

CUTTING PARTS



Blades - Rotary Cutter

BMB	21
Bush Hog	21-24
Ford	24-25
Howse/Hico	24
IMCO	25
Land Pride	25-26
Modern	26
Mohawk	27
Schulte	27-28
Service Rhino	28-30
Sidewinder	31-34
Terrain King	34-35
Tiger	36-37
US Mower	37
Woods	38-39

Blade Bolts & Kits

5/8"	4
3/4"	4-5
7/8"	6-7
1"	8-13
1-1/8"	15-17
1-1/4"	18
1-1/2"	18

Blade Carriers

Blade Carrier	19
Stump Jumper Pans	20

Box Blade Parts

Cutting Edges	20
Shanks, Shank Holders & Pins	20

Finishing Mower Blades 2-3

Tailwheel Hubs, Assembly, Forks 40-41

MODERN
AG PRODUCTS, LTD.

Finishing Mower Blades

We guarantee that every blade is hand straightened, produced from high-carbon boron-alloy steel, heat treated and austempered and is electrostatic power painted.

BIG BEE

Left Hand Cut



128-91045

Length: 19" / Center Hole: 17/32" / Width: 2-1/2"



128-91046

Length: 20" / Center Hole: 17/32" / Width: 2-1/2"



128-91047

Length: 25" / Center Hole: 17/32" / Width: 2-1/2"

BUSH HOG

(3) for 60" cut



128-91071 (Replaces OEM#: 82324)

Length: 21" / Center Hole: .5" / Width: 2-1/2"

CARONI



128-91140 (Replaces OEM#: 48007700)

Length: 16-7/8" / Center Hole: 3/4" / Width: 2"



128-91141 (Replaces OEM#: 59006200)

Length: 20-1/4" / Center Hole: 3/4" / Width: 2"



128-91142 (Replaces OEM#: 71001000)

Length: 24-1/8" / Center Hole: 3/4" / Width: 2"

KING KUTTER

Left Hand Cut



128-91452

Length: 20-1/16" / Center Hole: 17/32" / Width: 2"



128-91453

Length: 24" / Center Hole: 17/32" / Width: 2"

KUBOTA



128-91436 (Replaces OEM#: 76529-34330)

Model: (3) for 54" belly mower

Length: 18-5/8" / Center Hole: 1-1/8" / Width: 2-1/2"



128-91438 (Replaces OEM#: 76539-34330)

Model: (3) for 60" front mount

Length: 20-9/16" / Center Hole: 1-1/8" / Width: 2-1/2"

Finishing Mower Blades

We guarantee that every blade is hand straightened, produced from high-carbon boron-alloy steel, heat treated and austempered and is electrostatic power painted.

LANDPRIDE



128-91456 (Replaces OEM#: 890-172C)
Length: 24-29/32" / Center Hole: 1" / Width: 2-1/2"



128-91457 (Replaces OEM#: 890-171C)
Length: 20-15/16" / Center Hole: 1" / Width: 2-1/2"

SOUTHEAST-BIG OX



900-7284
Length: 16-1/4" / Center Hole: 3/8" / Width: 2-3/4"



900-7285
Length: 20-1/4" / Center Hole: 3/8" / Width: 2-3/4"

WOODS



128-91428 (Replaces OEM#: 12170)
Model: Model: RM48K, 304K, U304H,
U304M15, 348's.
Length: 16-3/4" / Center Hole: 5/8" / Width: 1-3/4"



128-91760 (Replaces OEM#: 5081)
Model: LH Cut
Length: 16-3/4" / Center Hole: 5/8" / Width: 1-3/4"



128-91761 (Replaces OEM#: 23825 & 31359)
Model: Left Hand Cut, (3) For 60" Cut
RM500, F35, RM59
Length: 20-3/16" / Center Hole: 5/8" / Width: 2"

WOODS



128-91762 (Replaces OEM#: 6950)
Model: Medium lift, (3) for 60" cut,
Model 59C2,
Length: 20-3/16" / Center Hole: 5/8" / Width: 2"



128-91764 (Replaces OEM#: 13404 & 31306)
Model: Left hand cut
(3) for 72" cut; L306, RM306 & RM600.
Length: 24-7/16" / Center Hole: 1" / Width: 2-1/2"



128-91766 (Replaces OEM#: 15127)
(3) for 72" Cut
Length: 24-5/8" / Center Hole: 5/8" / Width: 250-250



128-91767 (Replaces OEM#: 24590)
Model: Blade tip
Length: 11-1/2" / Center Hole: 7/8"

Rotary Cutter Blade Bolt Kits

5/8"

KIT# 7002328KIT

Commonly Fits:

BMB

For Models:
Various



COMPONENTS

BOLT# 501-0831



NUT# 501-0835



3/4"

KIT# B36107A2ALH

Commonly Fits:

Servis/Rhino

For Models:
Saturn 5,6,7 & 8 Gyro 66
& 140. LH

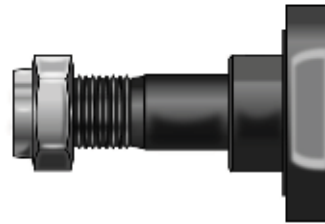

COMPONENTS

BOLT# 125-908

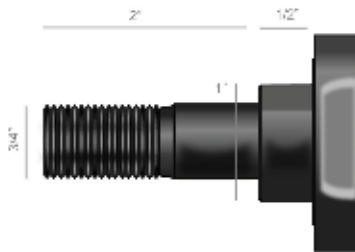

NUT# 5GL12160



Left Hand Thread

Rotary Cutter Blade Bolt Kits

5/8"

KIT# 7002328KIT

Commonly Fits:

BMB

For Models:
Various



COMPONENTS

BOLT# 501-0831

NUT# 501-0835



3/4"

KIT# B36107A2ALH

Commonly Fits:

Servis/Rhino

For Models:
Saturn 5,6,7 & 8 Gyro 66
& 140. LH

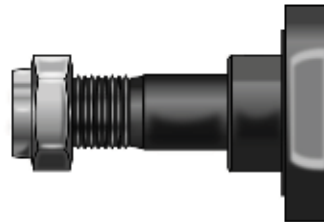

COMPONENTS

BOLT# 125-908

NUT# 5GL12160

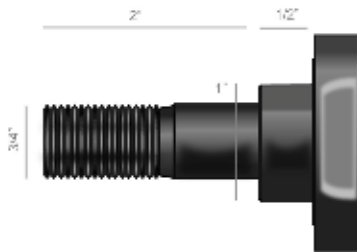

Rotary Cutter Blade Bolt Kits

KIT# 125-906

Commonly Fits:

Ford

For Models:
901 Series.
22-47 & 70 5 ft. cutters

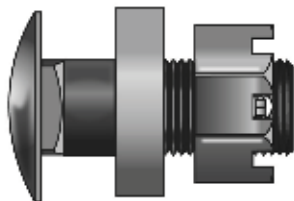

KIT SOLD COMPLETE
*Items not available
individually*

COMPONENTS

BOLT

WASHER

NUT

COTTER PIN

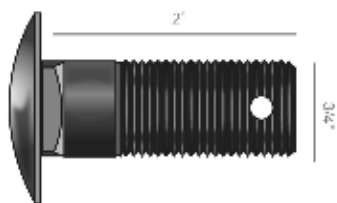

KIT# 125-910KIT

Commonly Fits:

Servis/Rhino

For Models:
1310 Shredder

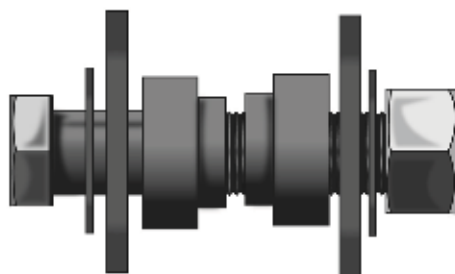

3/4"

COMPONENTS

BOLT# 125-915

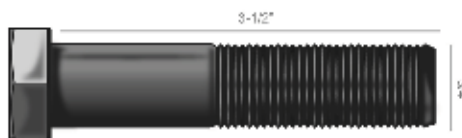

BUSHING# 125-911
(QTY 2)



WASHER# 125-912
(QTY 2)



WASHER# 125-914
(QTY 2)



NUT# 125-916
(QTY 1)



Rotary Cutter Blade Bolt Kits

3/4"

Commonly Fits:
Servis/Rhino

For Models:
Saturn 5,6,7 & 8 Gyro 66
& 140. LH

KIT# 125-927KIT

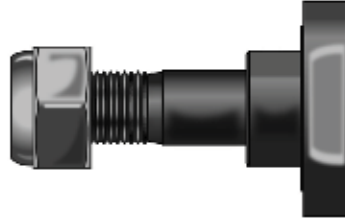

COMPONENTS

BOLT# 125-908

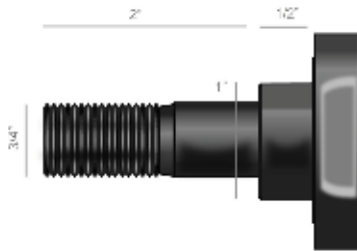

NUT# 125-923



KIT# 125-955KIT

Commonly Fits:
Bush Hog

For Models:
Various

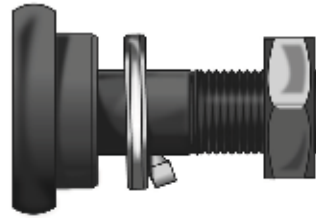

7/8"

COMPONENTS

BOLT# 125-953

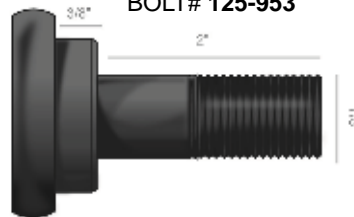

LOCK WASHER# 412-0080



NUT# 125-954



Rotary Cutter Blade Bolt Kits

KIT# 7-220-01

Commonly Fits:

Mohawk

For Models:
With a 1-1/2" hole

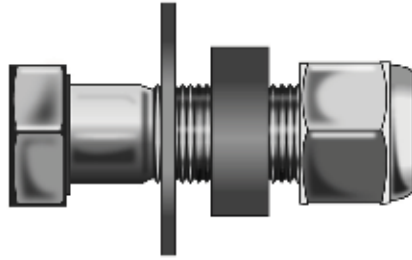

COMPONENTS

WASHER# 7-221



BOLT# 7-220

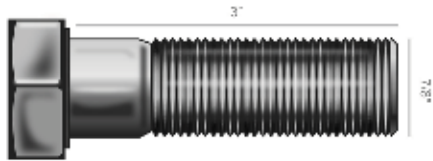

BUSHING# 6-809



NUT# 31M



KIT# 7-220-02

Commonly Fits:

Mohawk

For Models:
With a 1-1/4" hole

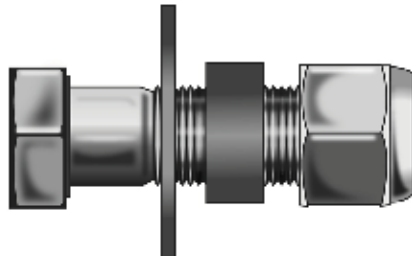

COMPONENTS

WASHER# 7-221

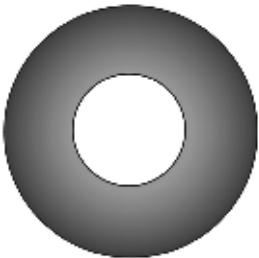

BOLT# 7-220

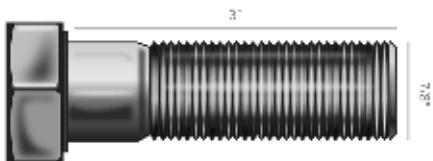

BUSHING# 6-806



NUT# 31M



7/8"

Rotary Cutter Blade Bolt Kits

Commonly Fits:

Mohawk

For Models:
Various

KIT# 1-220KIT

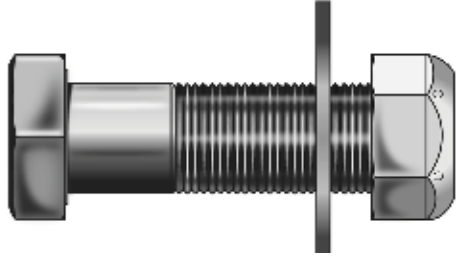

COMPONENTS

BOLT# 300-25464

WASHER# 412-7975

NUT# 8201

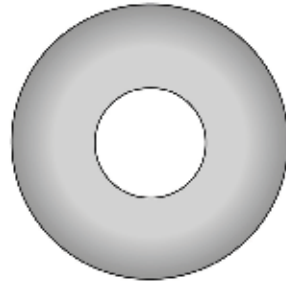
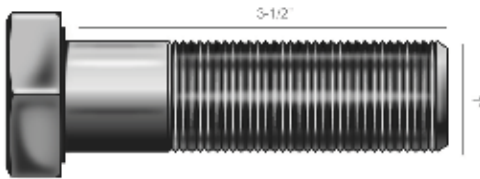

1"

Commonly Fits:

Modern

For Models:
Various/LH

KIT# 125-926KIT

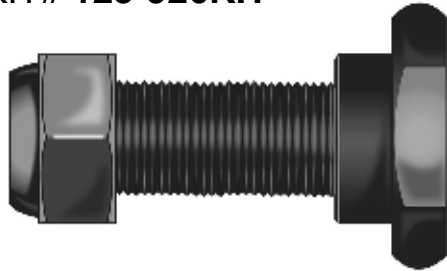

COMPONENTS

BOLT# 125-902

NUT# 125-922

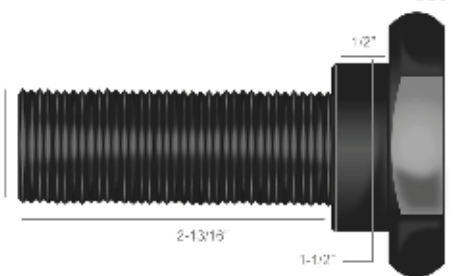

MODERN
AG PRODUCTS, LTD.

Rotary Cutter Blade Bolt Kits

Commonly Fits:
Sidewinder

For Models:
Various

KIT# 125-950KIT

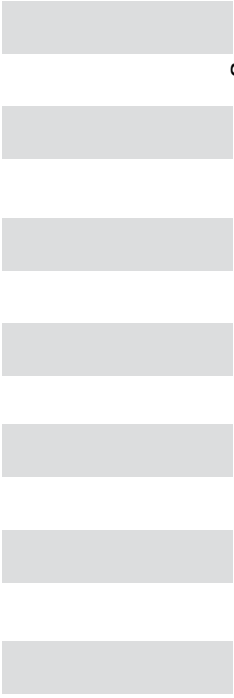
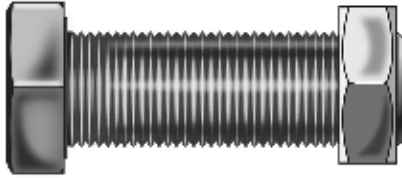

COMPONENTS

BOLT# 300-16196 **NUT# 300-16198**

1"

Commonly Fits:
Sidewinder

For Models:
With 3/8 Blades

KIT# 125-951KIT

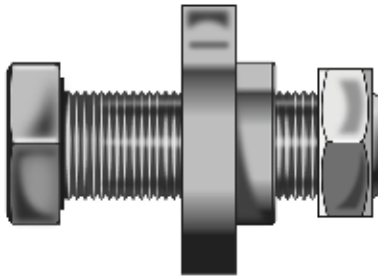

COMPONENTS

BUSHING# 125-918

BOLT# 300-16196 **NUT# 300-16198**

Rotary Cutter Blade Bolt Kits

KIT# 125-952KIT

Commonly Fits:
Sidewinder

For Models:
With 1/2 Blades

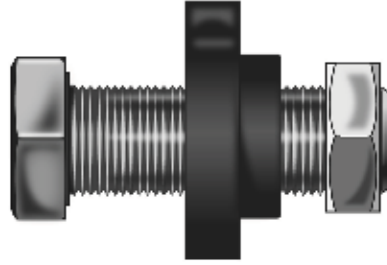

COMPONENTS

BUSHING# 125-919

BOLT# 300-16196

NUT# 300-16198

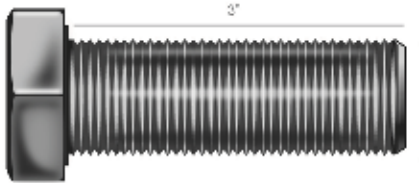

1"

KIT# 412-8043

Commonly Fits:
Modern

For Models:
Various/LH

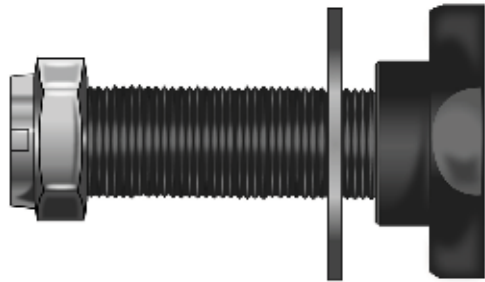

COMPONENTS

WASHER#
412-7975

BOLT# 412-0057

NUT# 412-0067-01

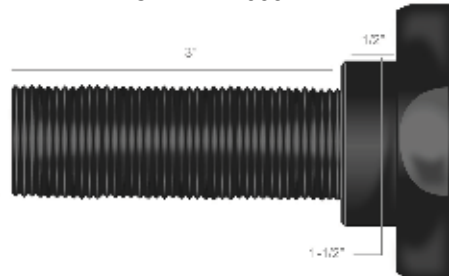

Rotary Cutter Blade Bolt Kits

KIT# 412-8043-02

Commonly Fits:
Modern

For Models:
Various

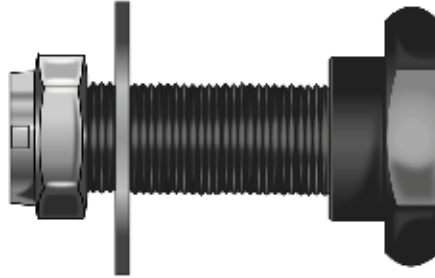

COMPONENTS

BOLT# 125-902

WASHER# 412-7975

NUT# 412-0067-01

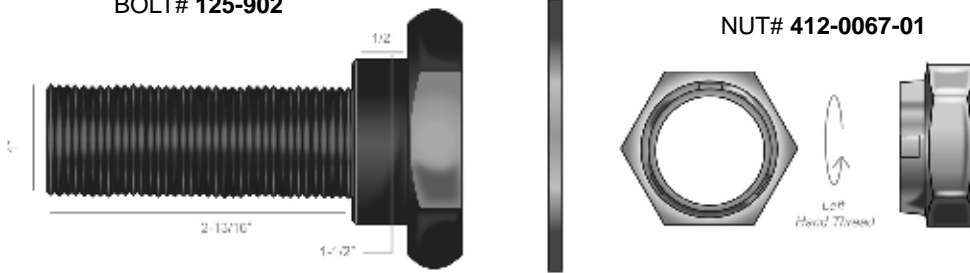

KIT# 700-8195 & 8264

Commonly Fits:
**BMB
Alamo
Terrain King**

For Models:
Various

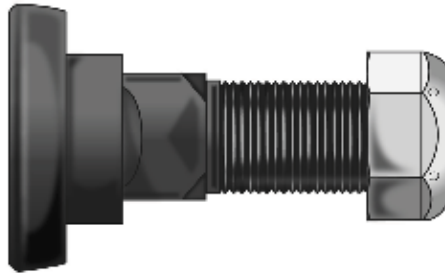

COMPONENTS

BOLT# 8227

NUT# 8201

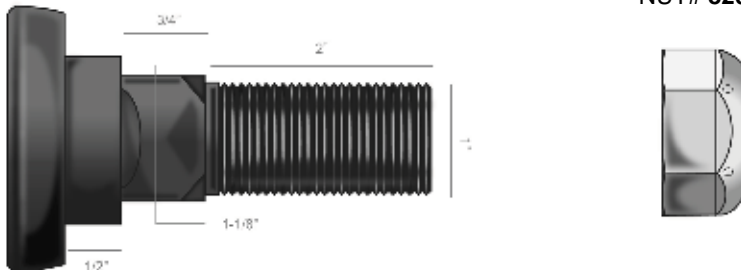

1"

Rotary Cutter Blade Bolt Kits

KIT# B571044



Commonly Fits:
Servis /Rhino

For Models:
Cyclone 60, 72,84,128; Flex 15,
Gyro 60,72,84,128,160

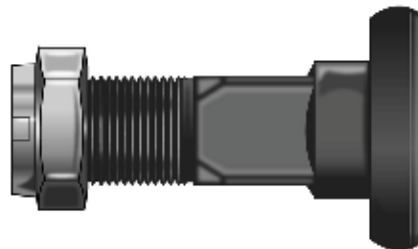

COMPONENTS

BOLT# 125-901

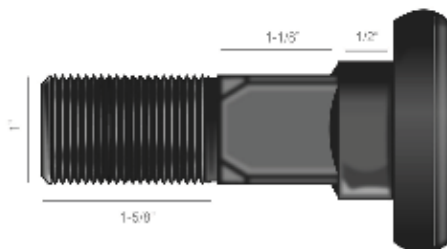

NUT# 412-0067-01

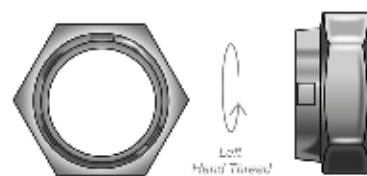

1"

KIT# C-458

Commonly Fits:
Hardee

For Models:
Various

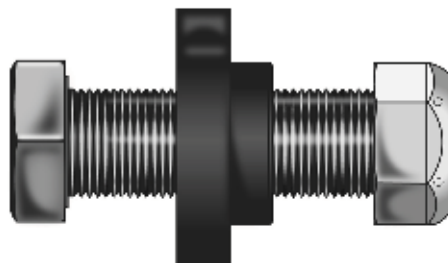

COMPONENTS

BUSHING# 125-919

BOLT# 610-850

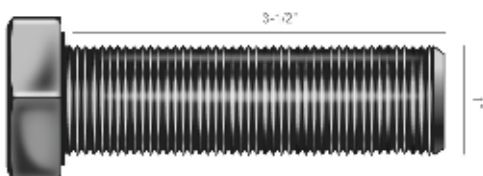

NUT# 8201

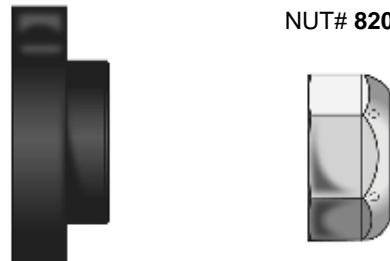

Rotary Cutter Blade Bolt Kits

KIT# RCM4-2 & RCM5-2

Commonly Fits:
XL Cutters

For Models:
Imported/Chinese

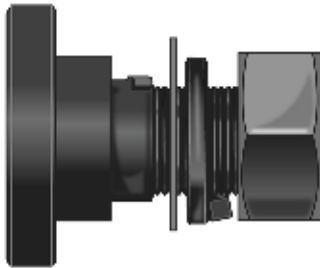

KIT SOLD COMPLETE
*Items not available
individually*

COMPONENTS

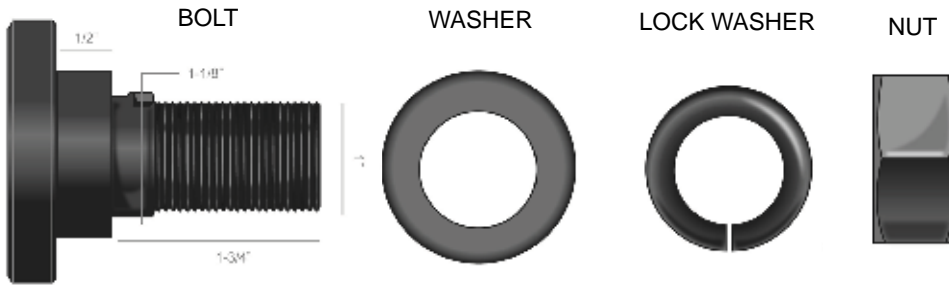

1"

KIT# 125-909KIT & 125-928KIT

Commonly Fits:
Howse

For Models:
Replacement for
Howse HL418N

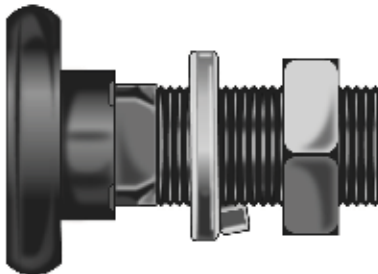

COMPONENTS



1 1/8"

NEW!
Tiger
Blade Bolts

BOLT# 125-06538000

BOLT# 125-34497

Rotary Cutter Blade Bolt Kits

Commonly Fits:
Sidewinder

KIT# 125-913HW

For Models:
GB602, 722, 725, 842,
RS160, RS213,
FLEXWING 16 & 216

Note: Bolt is shaved on one side

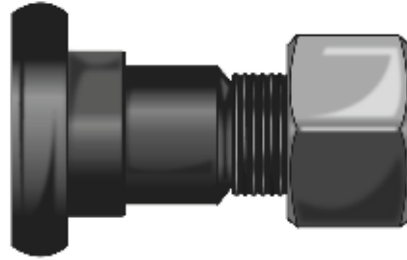

COMPONENTS

BOLT# 125-929

1 1/2" 1-1/2" 3"

NUT# 125-924

Shaved Side 13/16" 1-1/8"

Commonly Fits:
Howse

KIT# 125-917KIT

For Models:
Big Bee, Burroughs, Dale Phillips, Fred Cain
(BH-250), Fresno Mfg., Grizzley, International,
J-Bar, King Kutter, Kodiak (124-SMHD), L & S
(BB55), Lowery, M.K. Martin, Rollins, Samson,
Southern (123-RMH), Taylor Pittsburgh, Teb-
ben, Wallace & Worksaver.

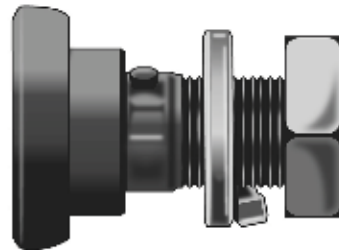

COMPONENTS

BOLT# 125-905

1 1/2" 2-1/2"

LOCK WASHER# 900-8771

NUT# 125-925

1 1/8"

Rotary Cutter Blade Bolt Kits

KIT# 125-931KIT

Commonly Fits:
Terrain King

For Models:
Various

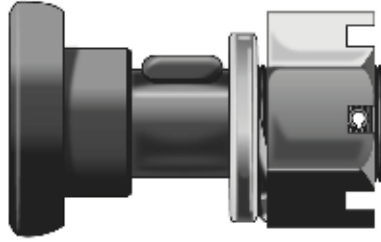

COMPONENTS

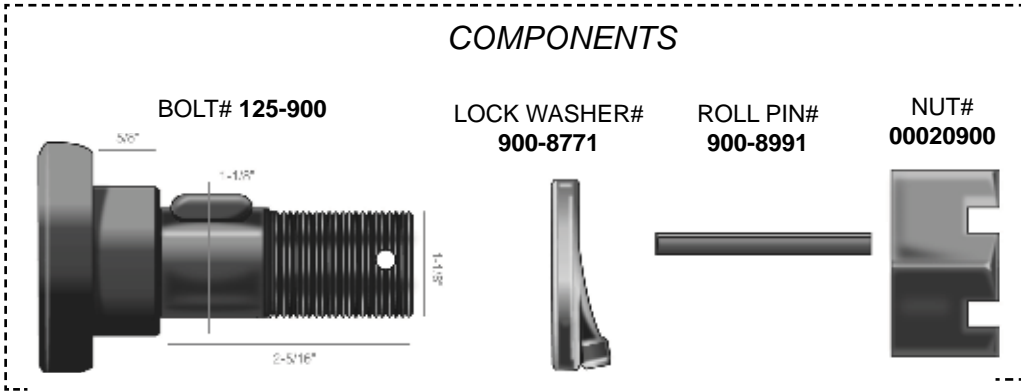

KIT# 125-940KIT

Commonly Fits:
Tiger

For Models:
Various

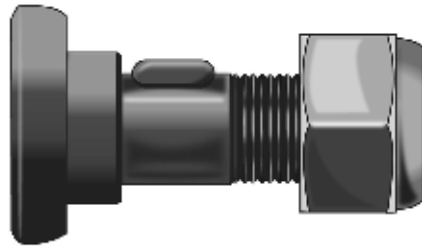

COMPONENTS

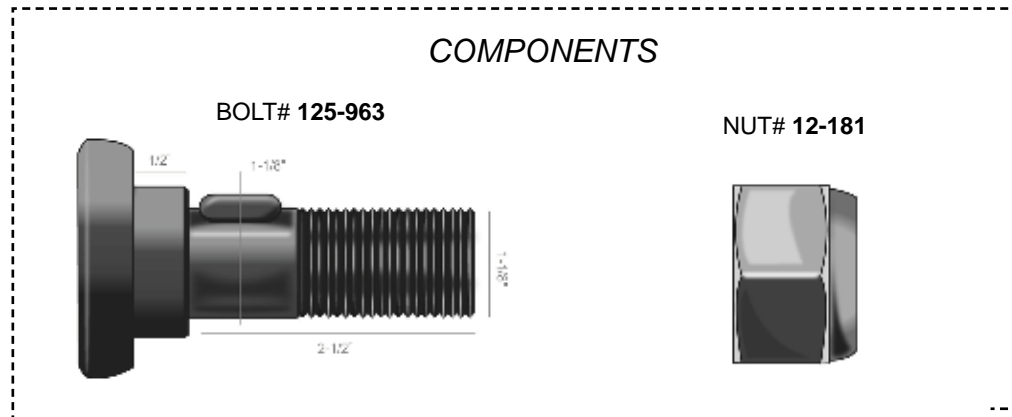

1 1/8"

Rotary Cutter Blade Bolt Kits

1 1/8"

Commonly Fits:
Bush Hog
Bushwacker
Modern
Southeast

For Models:
 Various

KIT# 412-8043-01

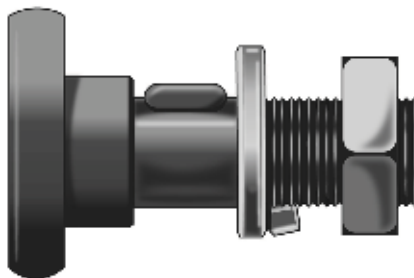

COMPONENTS

BOLT# 125-907

LOCK WASHER# 900-8771

NUT# 125-925

Commonly Fits:
Modern

For Models:
 4' & 5' Super Sunshine
 4' & 5' Competitor

KIT# 412-8043-03

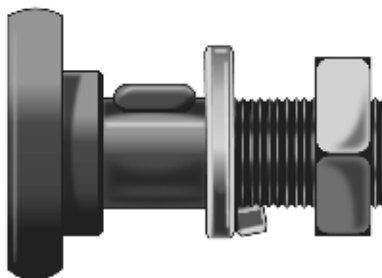

COMPONENTS

BOLT# 412-0057-03

LOCK WASHER# 900-8771

NUT# 125-925

Rotary Cutter Blade Bolt Kits

KIT# 02964330KIT

Commonly Fits:

Alamo

For Models:
Various

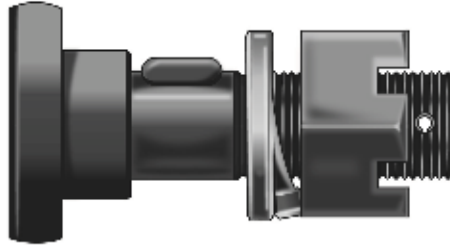

COMPONENTS



KIT# HL418N

Commonly Fits:

Howse/Hico

For Models:
Various

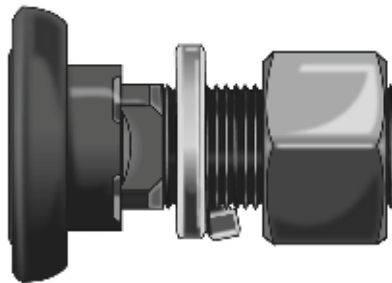

KIT SOLD COMPLETE
*Items not available
individually*

COMPONENTS

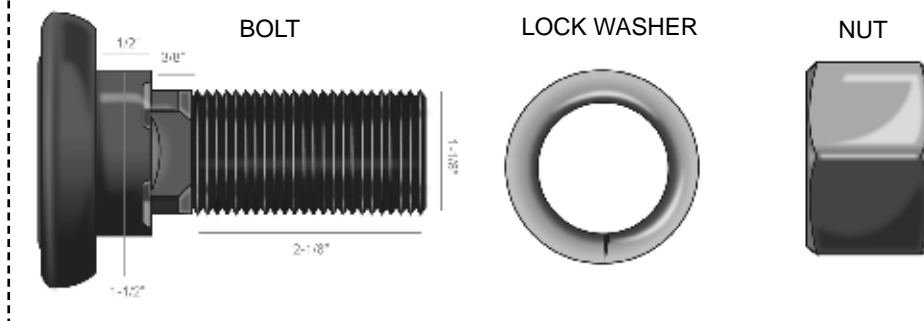

1 1/8"

Rotary Cutter Blade Bolt Kits

KIT# 125-949

Commonly Fits:
Hardee

For Models:
Various

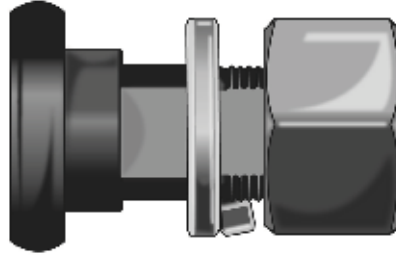

KIT SOLD COMPLETE
Items not available
individually

1 1/4"

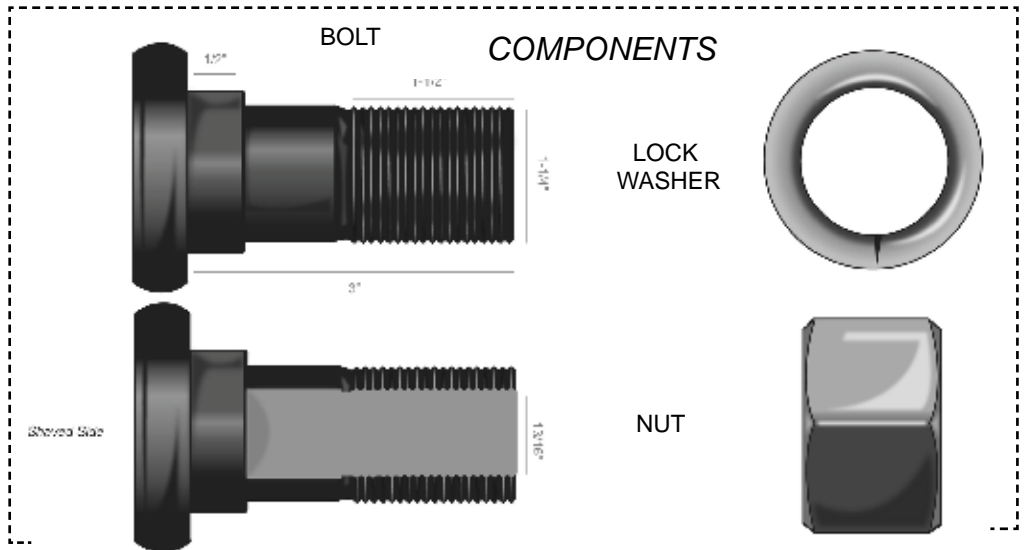

1 1/2"

Commonly Fits:
Woods

For Models:
M4, M5, 60, 72, 84, C80, MC80, 120Q,
R105, 5106, 5120, 210, D210R, B214,
B315, D315, D320, SM2090

KIT# 125-921KIT

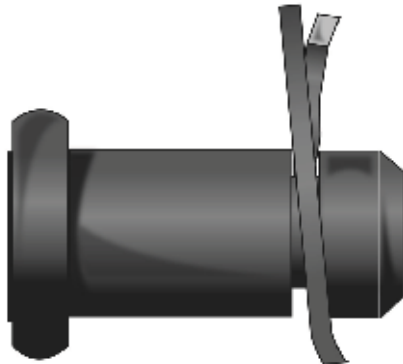

BOLT# 125-903

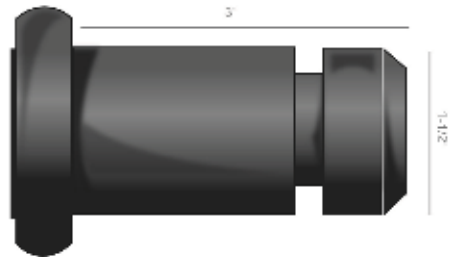

CLAMP KIT# 125-920



ROTARY CUTTER BLADE CARRIERS

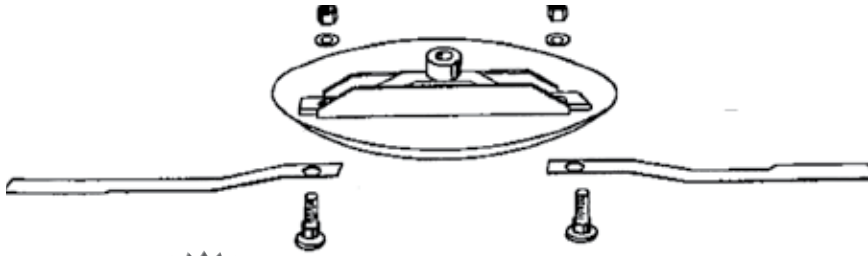

PART NO. 300-26176

Fits Sidewinder
 15 Spline Hub • 28" Ctr - Ctr Blade Bolt Holes.
 Half Moon Holes • Includes Stump Jumper Pan

Note: Blades, Bolts, and Hardware not included.

PART NO. 401-5450

*Fits Modern 4' - 5' - 6' Competitor and
 Sunshine Series Cutters
 12 Spline Hub
 15 1/2" Ctr - Ctr Blade Bolt Holes
 1 1/8" Keyed Blade Bolt Holes
 Includes Stump Jumper Pan*

PART NO. 16-158-01

*Fits Howse, King, International and
 Mohawk Cutters
 15 Spline Hub
 14" Ctr - Ctr Blade Bolt Holes
 1 1/8" Keyed Blade Bolt Holes
 Includes Stump Jumper Pan*

PART NO. 401-5455

*Fits Modern 5' and 6' Highway Special
 Cutters
 15 Spline Hub
 15 1/2" Ctr - Ctr Blade Bolt Holes
 1 1/8" Keyed Blade Bolt Holes
 Includes Stump Jumper Pan*

PART NO. 300-26369

*Fits Sidewinder GB722, FW15, 215,
 216, GB5, GB6, FW315, 325, 415
 and 425 15 Spline Hub
 17 3/4" Ctr - Ctr Blade Bolt Holes
 "D" Style Bolt Holes
 Includes Stump Jumper Pan*

PART NO. 401-5460

*Fits Modern 7' Highway Special and
 Predator Cutters
 15 Spline Hub
 27 1/2" Ctr - Ctr Blade Bolt Holes
 1 1/8" Keyed Blade Bolt Holes
 Includes Stump Jumper Pan*

PART NO. 300-22983

*Fits Sidewinder PG210
 15 Spline Hub
 17 3/4" Ctr - Ctr Blade Bolt Holes
 Threaded Bolt Holes 1" NF
 Includes Stump Jumper Pan*

PART NO. 16-158

*Fits Howse, King, International and
 Mohawk Cutters
 12 Spline Hub
 14" Ctr - Ctr Blade Bolt Holes
 1 1/8" Keyed Blade Bolt Holes
 Includes Stump Jumper Pan*

PART NO. 300-22962

*Fits Sidewinder 6 x 6, GB90, GB96, GB 108
 12 Spline Hub
 17 3/4" Ctr - Ctr Blade Bolt Holes
 Threaded Bolt Holes 1" NF
 Includes Stump Jumper Pan*

STUMP JUMPER PANS FOR ROTARY CUTTERS

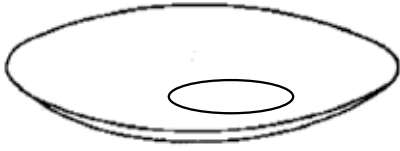

PART NO.	FITS	CENTER-TO-CENTER HOLE
401-0054-01	...MODERN 4', 5', 6' CUTTERS15-1/2"
401-0182	...MODERN 7' CUTTERS28"
300-17165	...ALL SIDEWINDER CUTTERS17-3/4"

BOX BLADE CUTTING EDGES

Replacement blades for box scrapers and rear mounted scrapers. Blades are double edged to increase life. Blades are made from 1/2" x 6" forged steel and require 5/8" plow bolts. Will fit most economy scrapers and box scrapers.

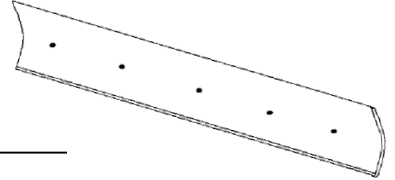

PART NO.	LENGTH	HOLES	HOLE PATTERN
416-78194'63-3-12-12-12-3-3
416-78254' 1/2"63-6-12-12-12-6-3
416-65645'63-9-12-12-12-9-3
402-64285' 1/2"63-12-12-12-12-3
416-84306'83-3-12-12-12-12-12-3-3
416-39067'83-9-12-12-12-12-12-9-3
416-84568'103-3-12-12-12-12-12-3-3
900-6917419'102-10-12-12-12-12-12-12-12-10-2
900-69174310'123-3-12-12-12-12-12-12-12-12-3-3

Note: Plow Screw (412-4699), Nut (412-0059), & Washer (412-0073) all fit box blade cutting edges

18 In. Box Blade Shank Front Notched with Point

Shank comes with point pre-installed.
Points are crimped on.

- 103-107 ...Box Blade Shank w/Point 16" Punched
- 103-109 ...Box Blade Shank w/Point 16" Rear Notched
- 402-8287 .Box Blade Shank w/Point 17-1/2" Front Notch
- 402-8287HBox Blade Shank w/Point 17-1/2" Front Notched

REPLACEMENT TINE
FOR ROCK RAKES
406-8601

REPLACEMENT PIN FOR SHANKS



1/2 x 3" Pin Fits
Our Shanks (Left)
Complete with Hairpin

Part No. 150-7111

REPLACEMENT POINT FOR BOX
BLADE SHANKS



Standard Tooth for
Box Scrapers

2-3/4" Boot

Part No. 100-3300 Imported
Part No. 402-8495 U.S.A.



PART NO.
402-8287H
Will fit:
Modern
Hardee

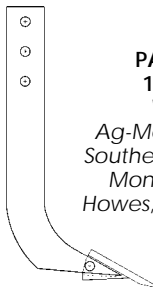

PART NO.
103-107
Will fit:
Ag-Meler, Kodiak
Souther, King Kutter
Monroe, Tuline
Howes, Great Plains

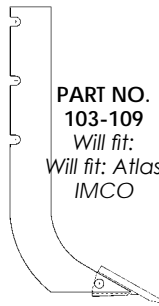

PART NO.
103-109
Will fit:
Will fit: Atlas
IMCO



PART NO.
402-8287
Will fit:
Modern
Hardee

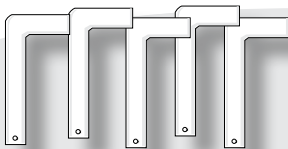

116-6220.. Square Shank Holder,
sold in quantities of (5)



ROTARY CUTTER BLADES

Catalog No. 700-8079

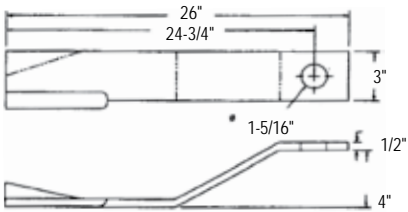

BMB

MODELS- XL-6, BR-6, FR-7, TBR-144 LH, MM CENTER
UPDRAFT **CCW ROTATION**

O.E.M. No.	Overall Length	Width at Edge	Thickness	Hole Size	Weight Ea.
BMB-8079	26"	3-1/2"	1/2"	1-5/16"	10.6 LBS

Catalog No. 700-8082

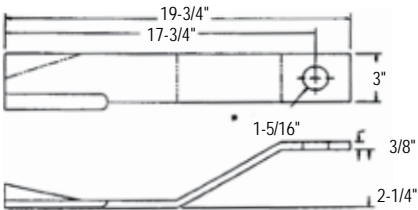

MODELS- B-4, B-5, UL, XL-5
UPDRAFT **CCW ROTATION**

O.E.M. No.	Overall Length	Width at Edge	Thickness	Hole Size	Weight Ea.
BMB-8082	19-3/4"	3-3/8"	3/8"	1-5/16"	6.5 LBS

Catalog No. 125-1201

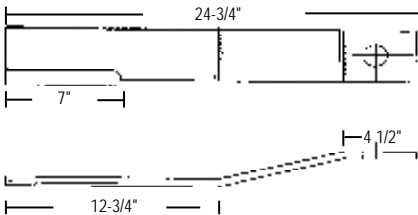

MODELS- 6, 12, 105, 205,
266, 305, 504, 600, 5-FT. **CCW ROTATION**

O.E.M. No.	Overall Length	Width at Edge	Thickness	Hole Size	Weight Ea.
462	24-3/4"	4"	1/2"	1-1/2"	11.8 LBS

Catalog No. 125-1202

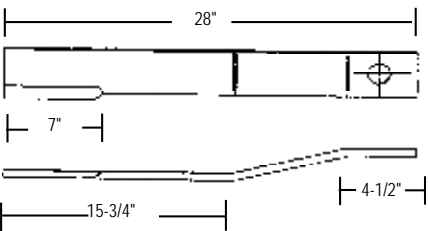

MODELS- 206, 306, 307, 6 - FT.
CCW ROTATION

O.E.M. No.	Overall Length	Width at Edge	Thickness	Hole Size	Weight Ea.
463	28"	4"	1/2"	1-1/2"	12 LBS

Catalog No. 125-1203

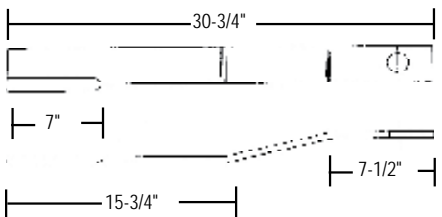

MODEL- 307, 7- FT.
CCW ROTATION

O.E.M. No.	Overall Length	Width at Edge	Thickness	Hole Size	Weight Ea.
464	30-3/4"	4"	1/2"	1-1/2"	13 LBS



ROTARY CUTTER BLADES



BUSH HOG (Continued)

Catalog No. 125-1204

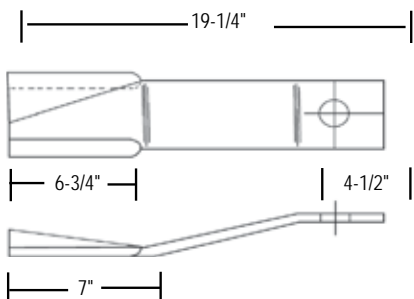

MODELS- 109 LEFT SIDE 2 USED, 109 OFFSET 4 USED, 160 RIGHT SIDE 2 USED, 160 CENTER 2 USED, 166 RIGHT SIDE 2 USED, 166 CENTER 2 USED, 1109 LEFT SIDE 2 USED, 1109 OFFSET 4 USED, 1166 RIGHT SIDE 2 USED, 1166 CENTER 2 USED, 1209 LEFT AISW 2 USED, 1600 RIGHT SIDE 2 USED, 1600 CENTER 2 USED.

CCW ROTATION

O.E.M. No.	Overall Length	Width at Edge	Thickness	Hole Size	Weight Ea.
7828 (Updraft)	19-1/4"	4"	1/2"	1-1/2"	11.5 LBS

Catalog No. 125-1205

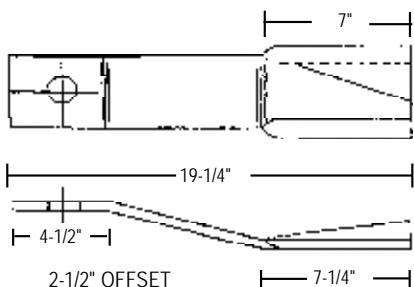

MODELS- 109 RIGHT SIDE 2 USED, 160 LEFT SIDE 2 USED, 166 LEFT SIDE 2 USED, 1109 RIGHT SIDE 2 USED, 1166 LEFT SIDE 2 USED, 1209 RIGHT SIDE 2 USED, 1600 LEFT SIDE 2 USED.

CW ROTATION

O.E.M. No.	Overall Length	Width at Edge	Thickness	Hole Size	Weight Ea.
7829 (Updraft)	19-3/4"	4-1/2"	1/2"	1-1/2"	11.5 LBS

Catalog No. 800-7555

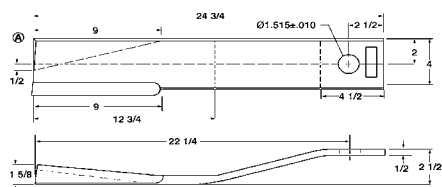

MODELS- 126 LEFT SIDE 2 USED, 126 OFFSET 4 USED, 310 RIGHT SIDE 2 USED, 315 RIGHT SIDE 2 USED, 1126 LEFT SIDE 2 USED, 1126 OFFSET 4 USED, 1226 LEFT SIDE 2 USED, 1310 RIGHT SIDE 2 USED, 1315 RIGHT SIDE 2 USED, 6 UPLIFT 2 USED, 12 UPLIFT 2 USED, 105 UPLIFT 2 USED, 205 UPLIFT 2 USED, 266 UPLIFT 2 USED, 305 UPLIFT 2 USED, 502 UPLIFT 2 USED, 600 UPLIFT 2 USED, 2615 RIGHT SIDE 2 USED. **CCW ROTATION**

O.E.M. No.	Overall Length	Width at Edge	Thickness	Hole Size	Weight Ea.
7555 (Updraft)	24-3/4"	4-1/2"	1/2"	1-1/2"	13.9 LBS

Catalog No. 800-7556

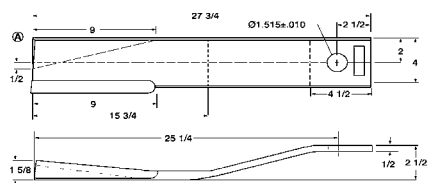

MODELS- 310 CENTER 2 USED, 315 CENTER 2 USED, 1310 CENTER 2 USED, 1315 CENTER 2 USED, 206 UPLIFT 2 USED, 306 UPLIFT 2 USED, 2615 CENTER 2 USED. **CCW ROTATION**

O.E.M. No.	Overall Length	Width at Edge	Thickness	Hole Size	Weight Ea.
7556 (Updraft)	27-3/4"	4-1/2"	1/2"	1-1/2"	15.7 LBS



ROTARY CUTTER BLADES



BUSH HOG *(Continued)*

Catalog No. 800-11150

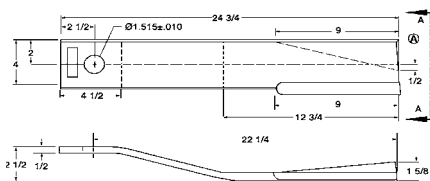

MODELS- 126 RIGHT SIDE 2 USED, 315 LEFT SIDE 2 USED, 1126 RIGHT SIDE 2 USED, 1226 RIGHT SIDE 2 USED, 1315 LEFT SIDE 2 USED, 2615 LEFT SIDE 2 USED.

CW ROTATION

O.E.M. No.	Overall Length	Width at Edge	Thickness	Hole Size	Weight Ea.
11150 (Updraft)	24-3/4"	4-1/2"	1/2"	1-1/2"	13.9 LBS

Catalog No. 125-1209

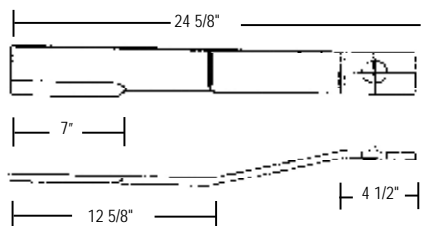

MODELS- 6, 12, 105, 205, 255, 266, 305, 502, 600, RB-60, SQUEELER 60.

CCW ROTATION

O.E.M. No.	Overall Length	Width at Edge	Thickness	Hole Size	Weight Ea.
36	24-5/8"	3-1/2"	1/2"	1-1/2"	10 LBS

Catalog No. 125-1210

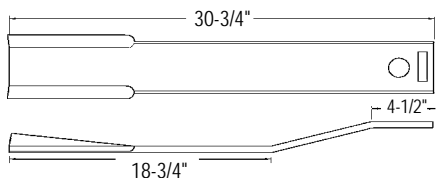

MODEL- 220 4 USED (2 RIGHT, 2 CENTER) UPDRAFT

CCW ROTATION

O.E.M. No.	Overall Length	Width at Edge	Thickness	Hole Size	Weight Ea.
7557	31"	4"	1/2"	1-1/2"	17.3 LBS

Catalog No. 125-1212

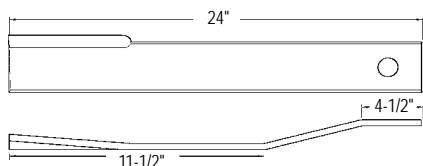

MODELS- 316S, 1312R, 3126 (2 USED), 3126R, 3210, 13126S.

CW ROTATION, UPDRAFT

O.E.M. No.	Overall Length	Width at Edge	Thickness	Hole Size	Weight Ea.
90014 78494	24"	4-1/2"	1/2"	1-1/2"	13.6 LBS

Catalog No. 125-78496

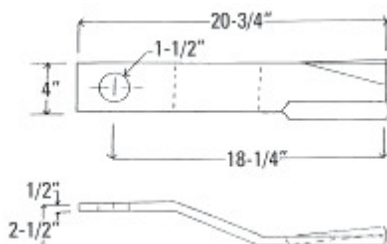

FITS:13168,3168. **CW ROTATION LIFT.** (2 USED)

O.E.M. No.	Overall Length	Width at Edge	Thickness	Hole Size	Weight Ea.
78496	20-3/4"	4"	1/2"	1-1/2"	13.6 LBS



ROTARY CUTTER BLADES



BUSH HOG (Continued)

Catalog No. 125-78497

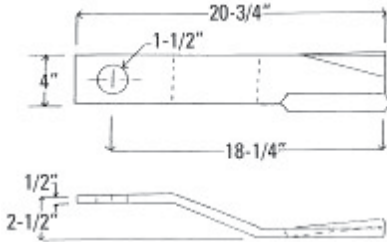

FITS:13168,3168. **CCW ROTATION** LIFT. (2 USED)

O.E.M. No.	Overall Length	Width at Edge	Thickness	Hole Size	Weight Ea.
78496	20-3/4"	4"	1/2"	1-1/2"	13.6 LBS

Catalog No. 125-81395

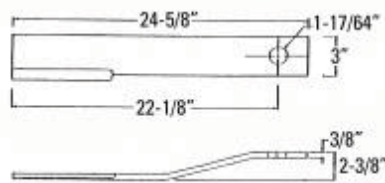

FITS: RAZORBACK RZ60-5 FOOT CUTTER

O.E.M. No.	Overall Length	Width at Edge	Thickness	Hole Size	Weight Ea.
81395	24-5/8"	3"	3/8"	1-17/64"	14 LBS

FORD

Catalog No. 125-1102

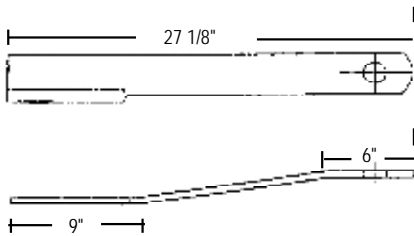

MODELS-910
CCW ROTATION

O.E.M. No.	Overall Length	Width at Edge	Thickness	Hole Size	Weight Ea.
7502411	27-1/8"	3-1/2"	1/2"	1-1/2"	12 LBS

HOWSE/HICO

Catalog No. 125-1415

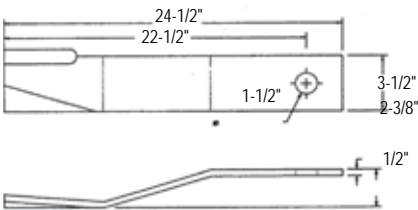

MODELS- 10 FT. UPDRAFT
CW ROTATION

O.E.M. No.	Overall Length	Width at Edge	Thickness	Hole Size	Weight Ea.
HL421-LN	24-1/2	N/A	1/2"	1-1/2	11.5 LBS

Catalog No. 125-1416

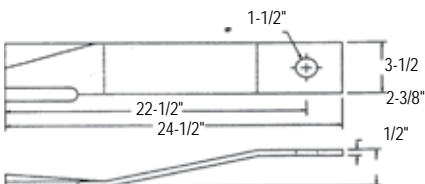

MODELS- 10 FT.
UPDRAFT **CCW ROTATION**

O.E.M. No.	Overall Length	Width at Edge	Thickness	Hole Size	Weight Ea.
HL421LN	24-1/2	N/A	1/2"	1-1/2	11.5 LBS



ROTARY CUTTER BLADES



HOWSE/HICO (Continued)

Catalog No. 125-1417

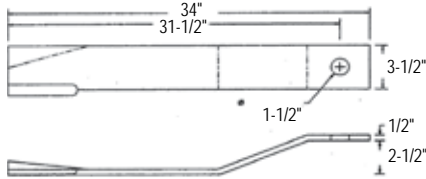

MODEL - 7 FT.
UPDRAFT **CCW** ROTATION

O.E.M. No.	Overall Length	Width at Edge	Thickness	Hole Size	Weight Ea.
HL423N	34"	4"	1/2"	1-1/2"	16.2 LBS

IMCO SOUTHEAST/BIG OX

Catalog No. 125-1151

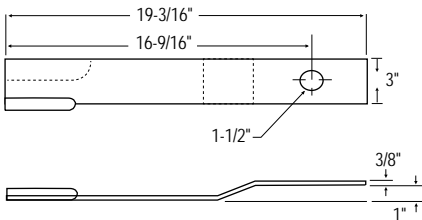

MODELS- 5 FT. UPDRAFT **CCW** ROTATION

O.E.M. No.	Overall Length	Width at Edge	Thickness	Hole Size	Weight Ea.
1500	19-3/16"	N/A	3/8"	1-1/2"	5.8 LBS

Catalog No. 125-1152

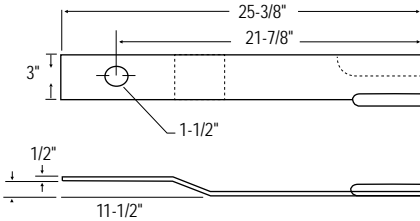

MODELS- 5 FT. UPDRAFT **CW** ROTATION

O.E.M. No.	Overall Length	Width at Edge	Thickness	Hole Size	Weight Ea.
1501	25-3/8"	N/A	1/2"	1-1/2"	10.2 LBS

LAND PRIDE

MODELS- RCR5015, RCR6015 CENTER BLADE.. **CCW** ROTATION 2-1/2" OFFSET. 26-1/2" CENTER HOLE TO END OF BLADE.

Catalog No. 820-168C

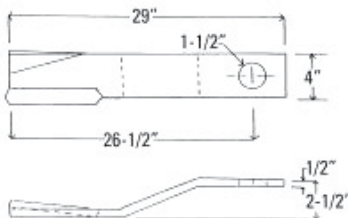

O.E.M. No.	Overall Length	Width at Edge	Thickness	Hole Size	Weight Ea.
820-168C	29"	4"	1/2"	1-1/2"	N/A

MODELS- RCR5015, RCR6015 LEFT HAND BLADE. **CCW** ROTATION LIFT.

Catalog No. 820-169C

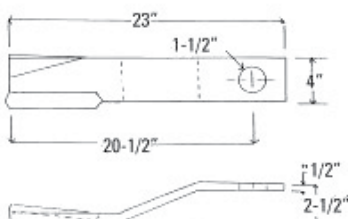

20-1/2" CENTER HOLE TO END OF BLADE.

O.E.M. No.	Overall Length	Width at Edge	Thickness	Hole Size	Weight Ea.
820-169C	23"	4"	1/2"	1-1/2"	14 LBS



ROTARY CUTTER BLADES



LAND PRIDE *(Continued)*

Catalog No. 820-170C

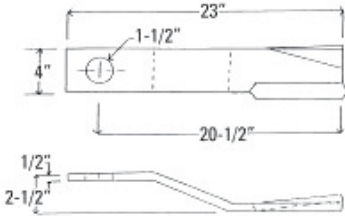

MODELS- RCR5015, RCR6015 LEFT HAND BLADE. **CW**
ROTATION LIFT. 20-1/2 CENTER HOLE TO END OF BLADE.

O.E.M. No.	Overall Length	Width at Edge	Thickness	Hole Size	Weight Ea.
820-170C	23"	4	1/2"	1-1/2"	14 LBS

MODERN

Catalog No. 125-1251

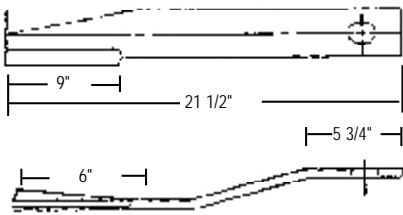

MODELS- ALL 5 FT., HIGHWAY SPECIAL
CCW ROTATION

O.E.M. No.	Overall Length	Width at Edge	Thickness	Hole Size	Weight Ea.
MC36867A 8-401-0179)	21-1/2"	4-1/2"	1/2"	1-1/2"	9.9 LBS

Catalog No. 401-0175S

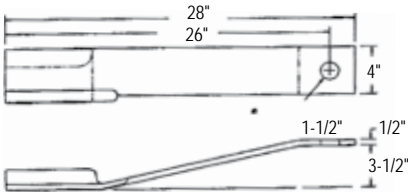

MODEL - 6' COMMANDO, 6' & 7' HWY SPECIAL, 6' & 7'
 SUPER COMMANDO UPDRAFT **CCW** ROTATION

O.E.M. No.	Overall Length	Width at Edge	Thickness	Hole Size	Weight Ea.
401-0175S	28"	4-1/2"	1/2"	1-1/2"	15.3 LBS

Catalog No. 401-0153

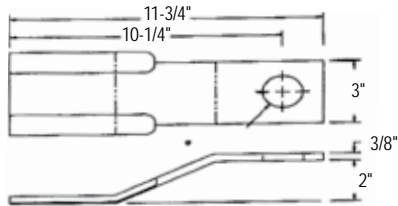

MODEL - 42" SUNSHINE, 42" COMPETITOR
 FLAT **CW/CCW** ROTATION

O.E.M. No.	Overall Length	Width at Edge	Thickness	Hole Size	Weight Ea.
401-0153	11-3/4"	3-1/2"	3/8"	1-1/2"	3.5 LBS

Catalog No. 401-0174S

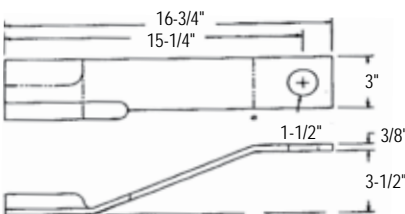

MODEL - 4' SUNSHINE, 4' COMMANDO, 4'
 COMPETITOR
 UPDRAFT **CCW** ROTATION

O.E.M. No.	Overall Length	Width at Edge	Thickness	Hole Size	Weight Ea.
401-0174S	16-3/4"	3-1/4"	3/8"	1-1/2"	5 LBS



ROTARY CUTTER BLADES



MOHAWK

Catalog No. 125-1301

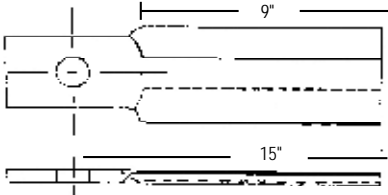

MODEL- 507
CW/CCW ROTATION

O.E.M. No.	Overall Length	Width at Edge	Thickness	Hole Size	Weight Ea.
1-210	15"	4"	1/2"	1-1/4"	5.5 LBS

Catalog No. 125-1302

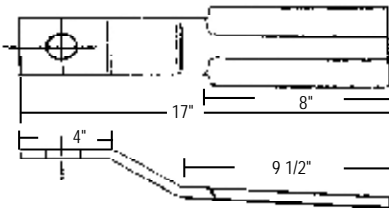

MODEL- 840, 1360
CW/CCW ROTATION

O.E.M. No.	Overall Length	Width at Edge	Thickness	Hole Size	Weight Ea.
1-214	17"	4"	1/2"	1-1/2"	7.3 LBS

Catalog No. 18-181AL

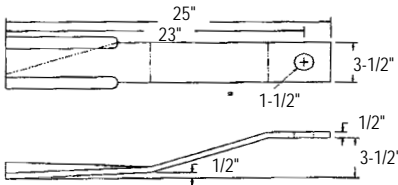

MODEL - 15' FLEX EAGLE (6 USED)
UPDRAFT CCW ROTATION

O.E.M. No.	Overall Length	Width at Edge	Thickness	Hole Size	Weight Ea.
18-181AL 7-724	25"	4-5/8"	1/2"	1-1/2"	11.9 LBS

SCHULTE

Catalog No. 401-026

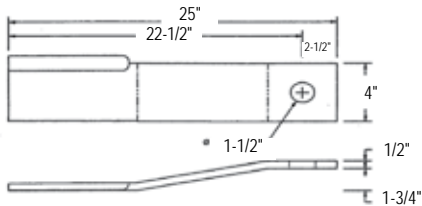

MODELS- XH1500
FLAT CW ROTATION

O.E.M. No.	Overall Length	Width at Edge	Thickness	Hole Size	Weight Ea.
401-026	25"	4-1/2"	1/2"	1-1/2"	13.3 LBS

Catalog No. 401-027

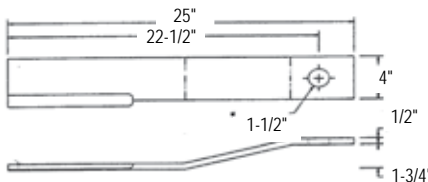

MODELS- XH1500, XH1000
FLAT CCW ROTATION

O.E.M. No.	Overall Length	Width at Edge	Thickness	Hole Size	Weight Ea.
401-027	25"	4-1/2"	1/2"	1-1/2"	13.3 LBS



ROTARY CUTTER BLADES



SCHULTE

Catalog No. 401-028

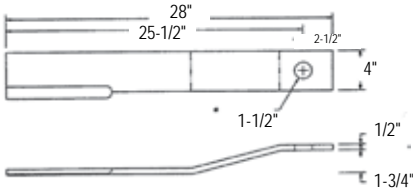

MODELS- XH1500
FLAT CCW ROTATION

O.E.M. No.	Overall Length	Width at Edge	Thickness	Hole Size	Weight Ea.
401-028	28"	4-1/2"	1/2"	1-1/2"	15.3 LBS

Catalog No. 401-032

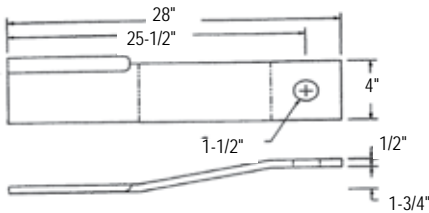

MODELS- XH1000
FLAT CW ROTATION

O.E.M. No.	Overall Length	Width at Edge	Thickness	Hole Size	Weight Ea.
401-032	28"	4-1/2"	1/2"	1-1/2"	15.3 LBS

SERVIS/RHINO

Catalog No. 00753841

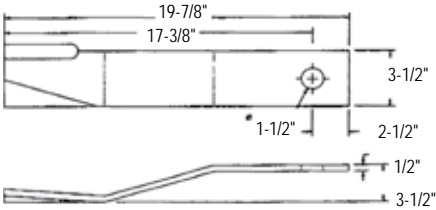

MODEL - SAT8, (2 USED), AFTER S/N 10340, SR120, SR166, TW96
UPDRAFT CW ROTATION

O.E.M. No.	Overall Length	Width at Edge	Thickness	Hole Size	Weight Ea.
00753841	19-7/8"	4"	1/2"	1-1/2"	9.1 LBS

Catalog No. 00753842

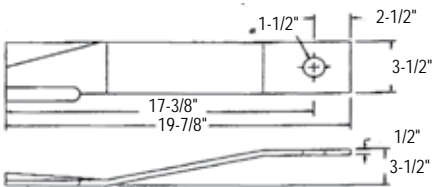

MODEL - SAT8 (2 USED) AFTER S/N 10340,
SR120, SR166, TW96
UPDRAFT CCW ROTATION

O.E.M. No.	Overall Length	Width at Edge	Thickness	Hole Size	Weight Ea.
00753842	19-7/8"	4"	1/2"	1-1/2"	9.1 LBS

Catalog No. 00759495

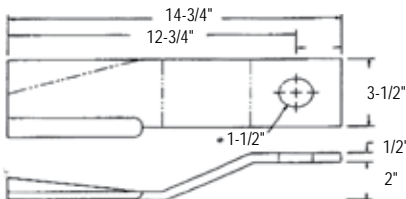

MODEL - SR80
UPDRAFT CCW ROTATION

O.E.M. No.	Overall Length	Width at Edge	Thickness	Hole Size	Weight Ea.
00759495	14-3/4"	3-1/4"	1/2"	1-1/2"	6.8 LBS



ROTARY CUTTER BLADES



SERVIS/RHINO

Catalog No. 125-1354

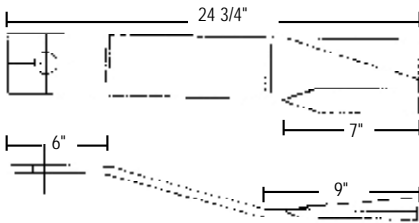

MODEL - CY128, FL15, FS15, S128, SR15

CW ROTATION

O.E.M. No.	Overall Length	Width at Edge	Thickness	Hole Size	Weight Ea.
65201-RF (Updraft)	24 3/4"	5"	1/2"	1-3/8"	10.5 LBS

Catalog No. 125-1355

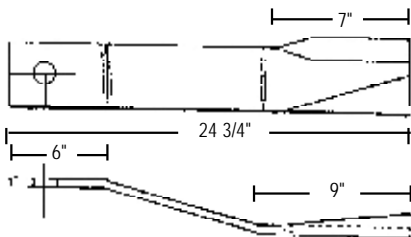

MODEL - CY128, CY60, FL15, FS15, S128, SM66, SR15

CCW ROTATION

O.E.M. No.	Overall Length	Width at Edge	Thickness	Hole Size	Weight Ea.
62201-3F (Updraft)	24 3/4"	5"	1/2"	1-3/8"	10.5 LBS

Catalog No. 125-1356

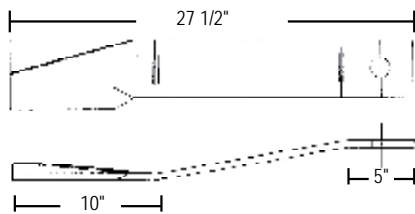

MODEL - CY72, FL15, FL20-BAR, SR15, SR15M, SR18

CCW ROTATION

O.E.M. No.	Overall Length	Width at Edge	Thickness	Hole Size	Weight Ea.
58201-3F (Updraft)	27-1/2"	5"	1/2"	1-3/8"	15 LBS

Catalog No. 125-1357

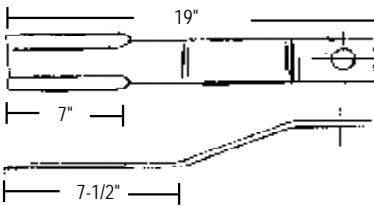

MODELS- 1310, SR166

CW/CCW ROTATION

O.E.M. No.	Overall Length	Width at Edge	Thickness	Hole Size	Weight Ea.
68-106-3	19"	5"	1/2"	1-3/8"	10.5 LBS

Catalog No. 125-1359

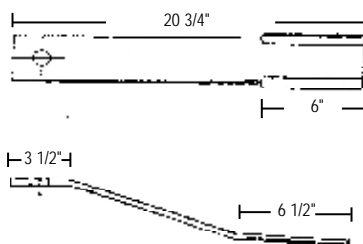

MODELS SATURN 8

CW/CCW ROTATION

O.E.M. No.	Overall Length	Width at Edge	Thickness	Hole Size	Weight Ea.
73-1300-010	20-1/4"	3-1/2"	3/8"	1"	4.5 LBS



ROTARY CUTTER BLADES



SERVIS/RHINO

Catalog No. 125-1360

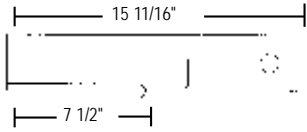

MODEL E60, SC80 - CCW ROTATION

O.E.M. No.	Overall Length	Width at Edge	Thickness	Hole Size	Weight Ea.
47-106-5B	15-11/16"	3-1/2"	.401"	1"	7 LBS

Catalog No. 125-1361

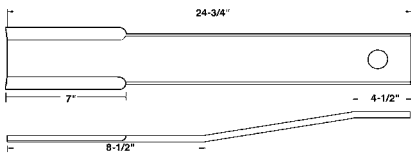

MODELS - FLEX 15 RIGHT - 2 USED LEFT - 2 USED, CY60, CY128, SM66, SR-15 CW/CCW ROTATION

O.E.M. No.	Overall Length	Width at Edge	Thickness	Hole Size	Weight Ea.
65-201-30	24-1/2"	5"	1/2"	1-3/8"	14 LBS

Catalog No. 125-1362

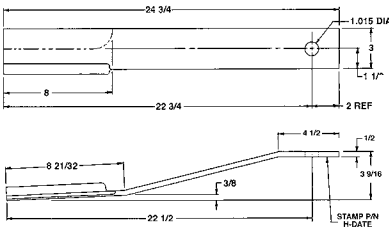

MODELS - SATURN 5 AND SE 6, FLEX S-15 - CCW ROTATION

O.E.M. No.	Overall Length	Width at Edge	Thickness	Hole Size	Weight Ea.
71-103	24-3/4"	3"	3/8"	1"	8.3 LBS

Catalog No. 125-1365

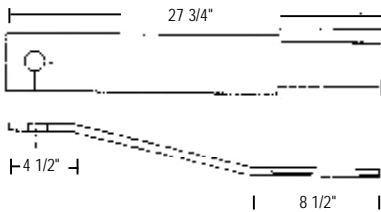

MODELS- CY60, FLEX 15 CENTER 2 USED, FLEX 20 WITHOUT STUMP JUMPER CW/CCW ROTATION

O.E.M. No.	Overall Length	Width at Edge	Thickness	Hole Size	Weight Ea.
58-201-030	27-3/4"	5"	1/2"	1-3/8"	16 LBS

Catalog No. 125-1366

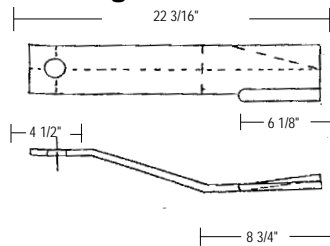

MODEL - SR 15 M - CW ROTATION RIGHT UPDRAFT

O.E.M. No.	Overall Length	Width at Edge	Thickness	Hole Size	Weight Ea.
00759338	22-3/16"	4-1/2"	1/2"	1-3/8"	12.4 LBS



ROTARY CUTTER BLADES



SERVIS/RHINO

Catalog No. 125-1367

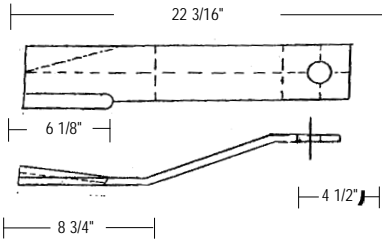

MODEL - SR 15 M -CCW ROTATION
LEFT UPDRAFT

O.E.M. No.	Overall Length	Width at Edge	Thickness	Hole Size	Weight Ea.
00759339	22-3/16"	4-1/2"	1/2"	1-3/8"	12.4 LBS

Catalog No. 125-1370

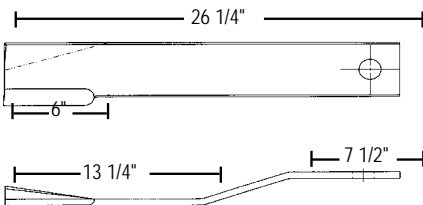

MODELS SE15, TW72, SR72 (SER. NO. 10205 & UP), A72, AG72B, A415, SUPERFLEX 15 III, SUPERFLEX 15 HD, SUPERFLEX 15
CCW ROTATION

O.E.M. No.	Overall Length	Width at Edge	Thickness	Hole Size	Weight Ea.
8588 (Updraft)	26 1/4"	4 1/2"	1/2"	1-1/2"	14 LBS

Catalog No. 125-1371

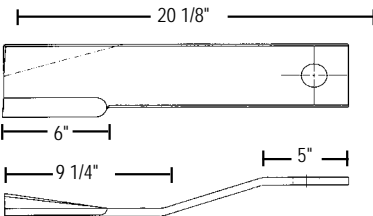

MODELS SE15, TW60, TW120, A60, AG60B, A415, SUPERFLEX 15 III, SUPERFLEX 15HD, SUPERFLEX 15, SR60 (SET NO. 10145 & UP) LEFT UPDRAFT - CCW ROTATION

O.E.M. No.	Overall Length	Width at Edge	Thickness	Hole Size	Weight Ea.
8589 (Updraft)	20 1/8"	4 1/2"	1/2"	1-1/2"	10.6 LBS

Catalog No. 125-1372

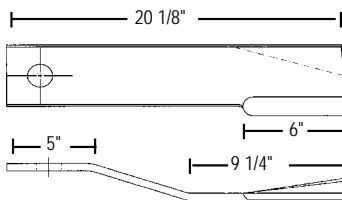

MODEL SE15, TW120, SUPERFLEX 15 III, SUPERFLEX 15HD, SUPERFLEX 15. RIGHT UPDRAFT CW ROTATION

O.E.M. No.	Overall Length	Width at Edge	Thickness	Hole Size	Weight Ea.
8590 (Updraft)	20 1/8"	4 1/2"	1/2"	1-1/2"	10.6 LBS

Catalog No. 125-1401

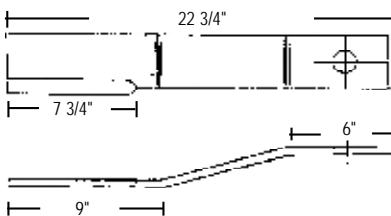

MODELS-GB602, GB605, GB60, GB660, SW 72 (TIRE DRIVE) CCW ROTATION

O.E.M. No.	Overall Length	Width at Edge	Thickness	Hole Size	Weight Ea.
15096	22-3/4"	4"	1/2"	1-1/2"	13 LBS

SIDEWINDER



ROTARY CUTTER BLADES

SIDEWINDER

Catalog No. 125-1402

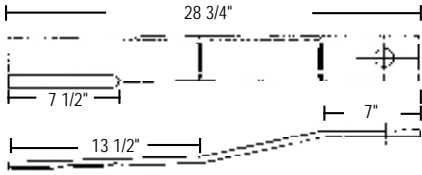

MODELS - 6X6, 7X7, GW842,
GB722,GB842, SW842, GB72, GB725,
S84, GB84 **CCW ROTATION**

O.E.M. No.	Overall Length	Width at Edge	Thickness	Hole Size	Weight Ea.
15120	28-3/4"	4"	1/2"	1-1/2"	14 LBS

Catalog No. 125-1403

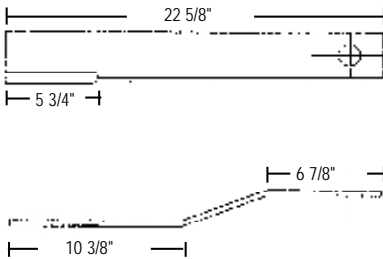

MODELS- SX60, 5X5
CCW ROTATION

O.E.M. No.	Overall Length	Width at Edge	Thickness	Hole Size	Weight Ea.
17065	22-5/8"	3-3/8"	3/8"	1-1/2"	6.5 LBS

Catalog No. 125-1404

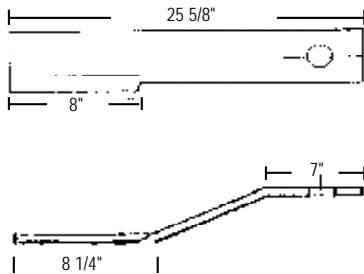

MODEL - FW325, FW425, FW215, FW315
CCW ROTATION

O.E.M. No.	Overall Length	Width at Edge	Thickness	Hole Size	Weight Ea.
22934LH (Updraft)	25-5/8"	4"	1/2"	1-1/2"	12.5 LBS

Catalog No. 125-1405

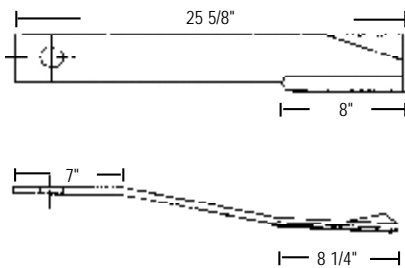

MODEL- FW325, FW425 FW215, FW315
CW ROTATION

O.E.M. No.	Overall Length	Width at Edge	Thickness	Hole Size	Weight Ea.
22935RH (Updraft)	22-5/8"	4"	1/2"	1-1/2"	12.5 LBS

Catalog No. 125-1406

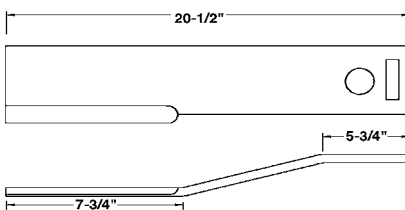

MODEL- GM66, SW66, GB48,
GB144, RS213 (TIRE DRIVE)
CCW ROTATION

O.E.M. No.	Overall Length	Width at Edge	Thickness	Hole Size	Weight Ea.
15074	20-1/2"	4"	1/2"	1-1/2"	10.5 LBS



ROTARY CUTTER BLADES



SIDEWINDER

Catalog No. 300-21301

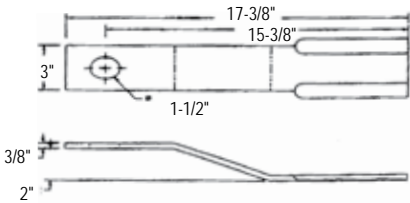

MODEL - LX60, SX42, SX50, GB90
FLAT CW/CCW ROTATION

O.E.M. No.	Overall Length	Width at Edge	Thickness	Hole Size	Weight Ea.
21301	17-3/8"	3-3/4"	3/8"	1-1/2"	5.2 LBS

Catalog No. 300-25899

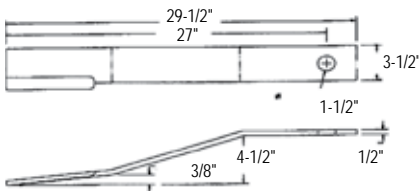

MODEL - GB6, GB7, SW7
FLAT CCW ROTATION

O.E.M. No.	Overall Length	Width at Edge	Thickness	Hole Size	Weight Ea.
25899	29-1/2"	4"	1/2"	1-1/2"	14.3 LBS

Catalog No. 300-25990

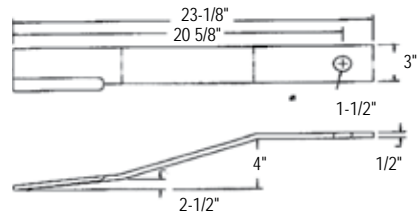

MODEL - GM60, 5X5 CW, MG5
FLAT CCW ROTATION

O.E.M. No.	Overall Length	Width at Edge	Thickness	Hole Size	Weight Ea.
25990	23-1/8"	N/A	1/2"	1-1/2"	9.4 LBS

Catalog No. 300-25992

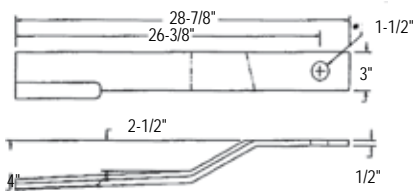

MODEL - GM72, 6X6CW, MG6
TWIST CCW ROTATION

O.E.M. No.	Overall Length	Width at Edge	Thickness	Hole Size	Weight Ea.
25992	28-7/8"	N/A	1/2"	1-1/2"	12.8 LBS

Catalog No. 300-26225

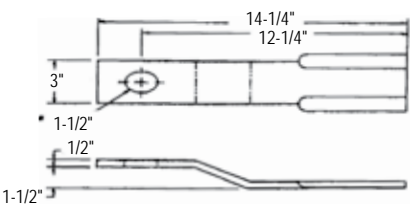

MODEL - GM42, GB10
FLAT CW/CCW ROTATION

O.E.M. No.	Overall Length	Width at Edge	Thickness	Hole Size	Weight Ea.
26225	14-1/4"	4"	1/2"	1-1/2"	5.5 LBS



ROTARY CUTTER BLADES

SIDEWINDER

Catalog No. 300-26226

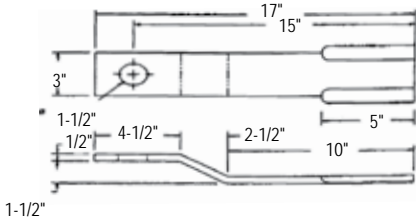

MODEL -GM48
FLAT CW/CCW ROTATION

O.E.M. No.	Overall Length	Width at Edge	Thickness	Hole Size	Weight Ea.
26226	17"	4"	1/2"	1-1/2"	6.8 LBS

Catalog No. 300-27485

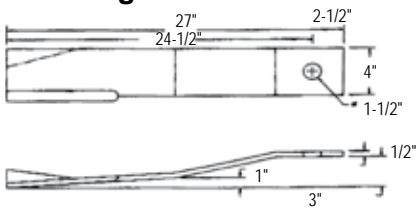

MODEL - FW425
UPDRAFT CCW ROTATION

O.E.M. No.	Overall Length	Width at Edge	Thickness	Hole Size	Weight Ea.
27485	27"	4-1/2"	1/2"	1-1/2"	14.6 LBS

Catalog No. 00752974

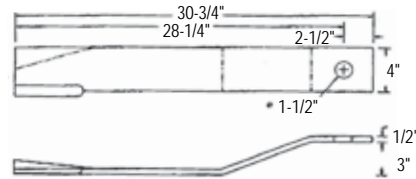

MODEL - TK84, MD84
UPDRAFT CCW ROTATION

O.E.M. No.	Overall Length	Width at Edge	Thickness	Hole Size	Weight Ea.
00752974	30-3/4"	4-1/2"	1/2"	1-1/2"	16.8 LBS

Catalog No. 02962635

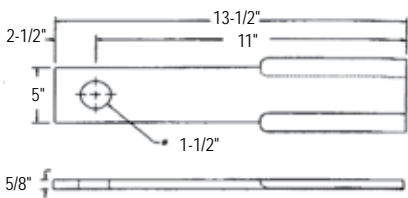

MODEL - BOOM AX MODELS
FLAT CW/CCW ROTATION

O.E.M. No.	Overall Length	Width at Edge	Thickness	Hole Size	Weight Ea.
02962635	13-1/2"	6-1/2"	5/8"	1-1/2"	11.2 LBS

Catalog No. 02964824

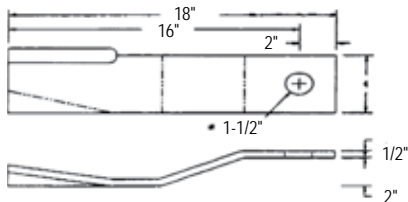

MODEL - A BOOM
UPDRAFT CW ROTATION

O.E.M. No.	Overall Length	Width at Edge	Thickness	Hole Size	Weight Ea.
02964824	18"	4-1/2"	1/2"	1-1/2"	10.8 LBS



ROTARY CUTTER BLADES

TERRAIN KING (Continued)

Catalog No. 125-1451

MODEL- SMC, MOWAL 15', TK-530 A-BOOM
CW/CCW ROTATION

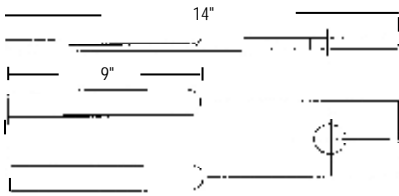

O.E.M. No.	Overall Length	Width at Edge	Thickness	Hole Size	Weight Ea.
1270-28	14"	4-1/4"	1/2"	1-1/4"	6 LBS

Catalog No. 125-1452

CCW ROTATION

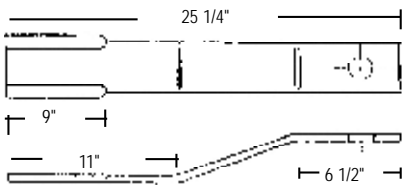

O.E.M. No.	Overall Length	Width at Edge	Thickness	Hole Size	Weight Ea.
750121	25-1/4"	4"	1/2"	1-1/2"	11.5 LBS

Catalog No. 125-1453

MODEL- TK15, TK15HD, A15IV, MD60, MD72, SR60 (up to 10145),
SR72 (up to 10205) HYDRO 15 RIGHT WING (UPDRAFT)
CCW ROTATION

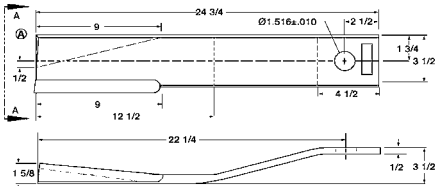

O.E.M. No.	Overall Length	Width at Edge	Thickness	Hole Size	Weight Ea.
750788	24-7/8"	4-1/2"	1/2"	1-1/2"	12 LBS

Catalog No. 125-1454

MODELS TK15, TK15HD, A15IV, DB60
CW ROTATION

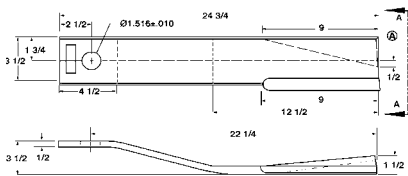

O.E.M. No.	Overall Length	Width at Edge	Thickness	Hole Size	Weight Ea.
750787	24-3/4"	4"	1/2"	1-1/2"	12 LBS

Catalog No. 125-1455

MODEL - BOOM AX MODELS
FLAT CW/CCW ROTATION

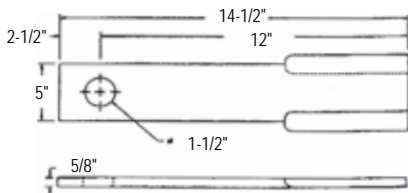

O.E.M. No.	Overall Length	Width at Edge	Thickness	Hole Size	Weight Ea.
02726900	14-1/2"	6-1/8"	5/8"	1-1/2"	12 LBS



ROTARY CUTTER BLADES



TIGER

Catalog No. 125-06521000

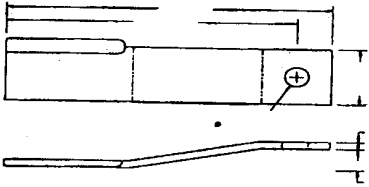

MODEL - SIDE MOUNT

O.E.M. No.	Overall Length	Width at Edge	Thickness	Hole Size	Weight Ea.
06521000	17"	5"	5/8"	1-3/4"	14 LBS

Catalog No. 125-06521001

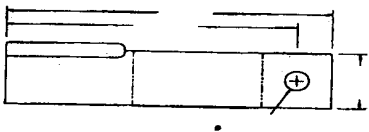

MODEL - SIDE MOUNT

O.E.M. No.	Overall Length	Width at Edge	Thickness	Hole Size	Weight Ea.
06521000	17"	5"	1/2"	1-1/2"	14 LBS

Catalog No. 125-1551

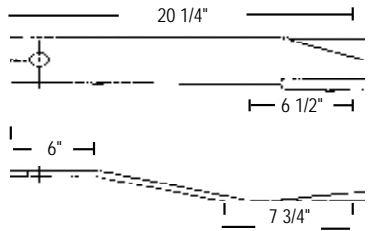

MODEL - SIDE MOUNT

O.E.M. No.	Overall Length	Width at Edge	Thickness	Hole Size	Weight Ea.
6T1021R	20-1/4"	4-1/2"	1/2"	1-1/2"	11.3 LBS

Catalog No. 125-1553

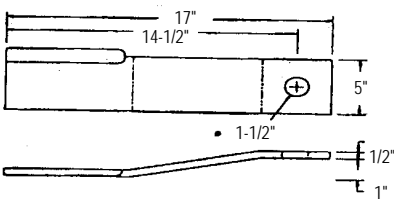

MODEL- BOOM FLAT CW ROTATION

O.E.M. No.	Overall Length	Width at Edge	Thickness	Hole Size	Weight Ea.
TB2031A	17"	5"	1/2"	1-1/2"	14 LBS

Catalog No. 125-34682

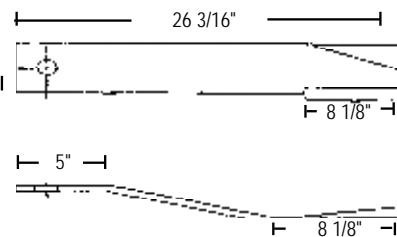

MODEL - SIDE MOUNT CCW ROTATION

O.E.M. No.	Overall Length	Width at Edge	Thickness	Hole Size	Weight Ea.
34682	26-3/16"	5"	1/2"	1-1/2"	14.1 LBS



ROTARY CUTTER BLADES

Forged from 5160
high quality steel.

TIGER (Continued)

Catalog No. 125-34688

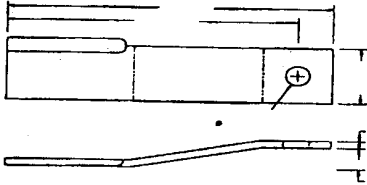

MODEL - SIDE MOUNT-HIGH SUCTION

O.E.M. No.	Overall Length	Width at Edge	Thickness	Hole Size	Weight Ea.
34688	17.375"	5"	5/8"	1-3/4"	14 LBS

Catalog No. 125-34684

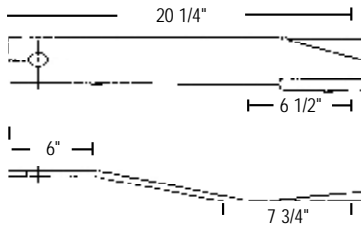

MODEL - SIDE MOUNT

O.E.M. No.	Overall Length	Width at Edge	Thickness	Hole Size	Weight Ea.
6T1021R	20"	4-1/2"	1/2"	1-3/4"	11.3 LBS



Catalog No. 125-6T7011A
DITCHER BLADE

US MOWER

Catalog No. 125-2558363

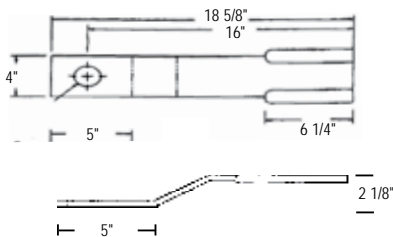

MODEL - SIDE MOUNT
CW/CCW ROTATION

O.E.M. No.	Overall Length	Width at Edge	Thickness	Hole Size	Weight Ea.
2558363	18-5/8"	5"	1/2"	1-1/2"	10 LBS



ROTARY CUTTER BLADES



WOODS

Catalog No. 125-1502

MODELS- R105, MR105, S105-1, S105-2 (4 USED)
P315-2, D315-3, HD315 - **CCW ROTATION**

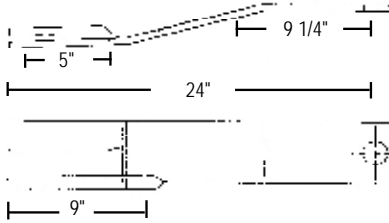

O.E.M. No.	Overall Length	Width at Edge	Thickness	Hole Size	Weight Ea.
12892L	24-1/8"	4-1/2"	.401	1-1/2"	11.9 LBS

Catalog No. 125-1504

MODEL- 42C- **CW ROTATION**

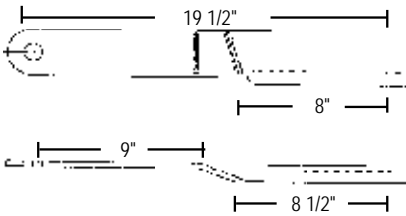

O.E.M. No.	Overall Length	Width at Edge	Thickness	Hole Size	Weight Ea.
3975	19-1/2"	3"	9/32"	7/8"	3.9 LBS

Catalog No. 125-1505

MODELS - M5-3, M54, 60-2,
60-3, 60-4, E60 - **CCW ROTATION**

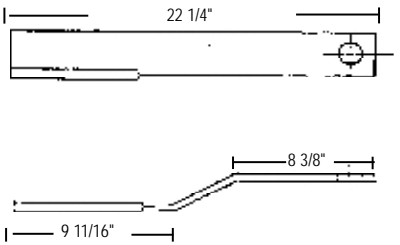

O.E.M. No.	Overall Length	Width at Edge	Thickness	Hole Size	Weight Ea.
6866	22-1/4"	3-1/2"	3/8"	1-1/2"	6.4 LBS

Catalog No. 125-1509

MODEL - 114 4 USED - **CCW ROTATION**

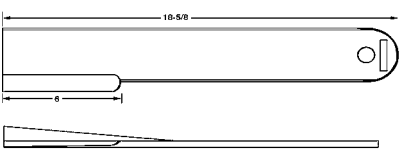

O.E.M. No.	Overall Length	Width at Edge	Thickness	Hole Size	Weight Ea.
3915	18-5/8"	3-1/2"	3/8"	7/8"	6.4 LBS

Catalog No. 125-1510

MODEL - 114 2 USED - **CCW ROTATION**

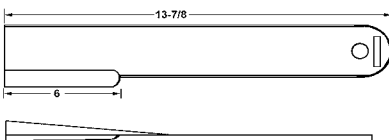

O.E.M. No.	Overall Length	Width at Edge	Thickness	Hole Size	Weight Ea.
3917	13-7/8"	3-1/2"	3/8"	7/8"	5.75 LBS



ROTARY CUTTER BLADES



WOODS (Continued)

Catalog No. 125-19160

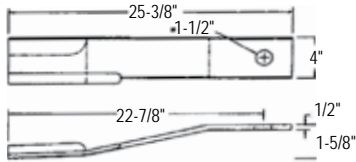

MODELS- 3180 (4 USED) L.H. & CTR
UPDRAFT **CCW** ROTATION

O.E.M. No.	Overall Length	Width at Edge	Thickness	Hole Size	Weight Ea.
19160	25-3/8	4-1/4"	1/2"	1-1/2"	13.7 LBS

Catalog No. 125-19161

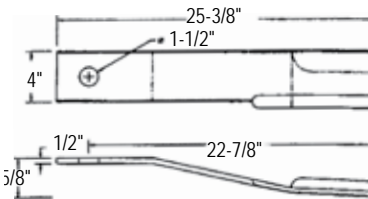

MODEL- 3180 (2 USED) R.H.
UPDRAFT **CW** ROTATION

O.E.M. No.	Overall Length	Width at Edge	Thickness	Hole Size	Weight Ea.
19161	25-3/8"	4-3/8"	1/2"	1-1/2"	13.7 LBS

Catalog No. 750-12916

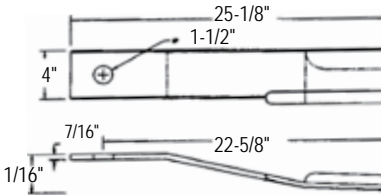

MODELS- HD210R-5, HD315-5
UPDRAFT **CW** ROTATION

O.E.M. No.	Overall Length	Width at Edge	Thickness	Hole Size	Weight Ea.
12916	25-1/8"	4-3/8"	7/16"	1-1/2"	11.9 LBS

Catalog No. 750-12917

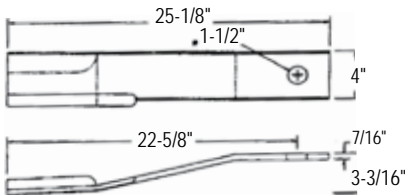

MODELS- HD210R-5, HD315-5
UPDRAFT **CCW** ROTATION

O.E.M. No.	Overall Length	Width at Edge	Thickness	Hole Size	Weight Ea.
12917	25-1/8"	4-3/8"	7/16"	1-1/2"	11.9 LBS

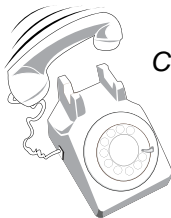

*Customer Service Representatives are available **M-F 8 am - 5:30 pm** & **Saturdays 8 am- 12 pm.** Ready to help you!*

A) Fabricated Tail Wheel Hub

Fits the most common model tail wheel assemblies. Comes with studs, nuts, and lockwashers.

- 325-2601 Tail wheel hub with studs, less bushings
 (2 bushings used per hub - not included).
- 325-2621 5/8" bushing
- 325-2622 3/4" bushing
- 325-2624 1" bushing

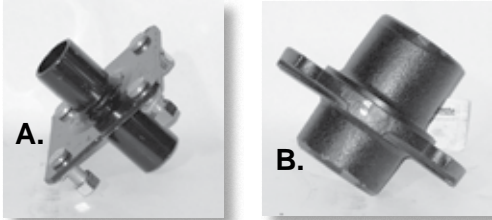

Tail Wheel Assembly Heavy Duty

1 1/2" dia. stem on yoke.
 Heavy Duty Cast Iron Hub with Bearing Races, seals, and axle bolt 325-2602

1 1/4" dia. stem on yoke.
 Heavy Duty Cast Iron Hub with Bearing Races, seals, and axle bolt 325-2605



6 x 9 Laminated Tire

Outside diameter 20", 5 bolt holes on 5-1/2" circle, 4" pilot hole. Fits most 15' batwing cutters. 103-211



4 x 8 Laminated Tire

Outside diameter 15", 4 bolt holes on 5" circle, 3-5/8" pilot hole. Fits most light, medium & heavy duty single deck cutters. 103-209



6 x 9 Laminated Tire 4 Hole (not shown)

Outside diameter 20", 4 bolt holes on 5" circle. Fits Woods Cutters. 401-8810

B) Cast Wheel Hub 325-2501

Hub and bearing kit for 4 bolt wheel above includes hub, stud bolts, bearing, cups, and seals - axle not included.

- 325-2510 Hubs only w/cups from 325-2501
- 325-2705KIT . . Bearings, cups, and seals kit for 4-bolt hub
- 324-3226 Bearing cup only L44610 for cast hub
- 324-3227 Bearing cone only L44643 for cast hub
- 322-2703 Seal only 7781-S for cast hub
- 325-2191 Bushing for 4 x 8 Tail Wheel
 1" ID x 1-1/4" OD x 1" long.
- 325-2195 Reducer bushing 1" to 3/4" axle
- 610-597 Wheelbolt stud only for tail wheel hub
- 401-3581-01 . . T/W Hub Complete , 1" Axle
- 401-3581A . . . T/W Hub Complete , 3/4" Axle

Rhino Hub w/Races & Studs

Replaces Hubs on Rhino 15' Cutters
 SR15-FL15-FL15M-FS15-SR15M • SE15 IV-SR18-SR20-SR166TW144-TW120-TW96
 00757241 • HUB ASSEMBLY COMPLETE
 00756489 • HUB W/RACES & STUDS
 00756528 • REPAIR KIT

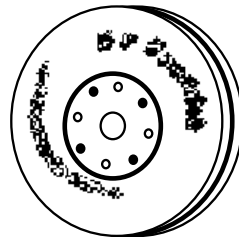

Aircraft Tailwheel

401-8812
 Size: 6x9" • Type: 5 Bolt
 Comes with valve stem

401-8812-04
 FOAM FILLED

TAIL WHEEL FORK



325-2192
 325-2603

- 325-2192 Fork Only, 1-1/2" Shaft for 325-2602
- 325-2602 Complete Assembly 1 1/2" Diameter Stem
- 325-2603 Fork Only 1-1/4" Shaft for 3/4" Axle;
 Also replaces: Bush Hog - 95541
 Taylorway - 505044 & Woods.
- 325-2605 Tail Wheel assembly, heavy duty , 1-1/4" Yoke

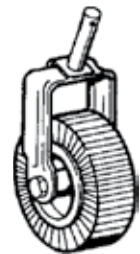

325-2602
 325-260

Tail Wheel Assembly

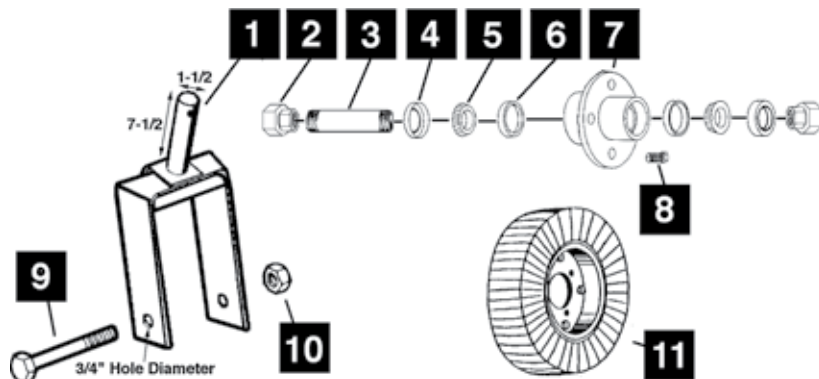

ITEM#	PART #	DESCRIPTION
1	325-2192	Fork Assembly
2	325-2626	Spindle Tube Nut
3	325-2625	Treaded Spindle Tube
4	322-1135	7781-S Grease Seal
5	324-5143	Inner Bearing Cone 15123
6	324-5144	Inner Bearing Cup 15245

ITEM #	PART #	DESCRIPTION
7	325-2506	Hub Only
	325-2507KIT	Hub Kit Fits Landpride & Taylor Pittsburg ; Includes Items: 2, 3, 4, 5, 6, 7.
8	512-0650	Wheel Bolt 1/2 x 1 UNF
9	412-0036	Bolt 3/4 X 8
10	412-0060	Nylon Lock Nut 3/4
11	103-209	Wheel Flange & Tire Assy.

BUSH HOG TAIL WHEEL PARTS

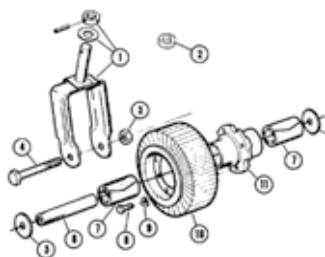

ITEM#	REPLACES#	PART NO.	DESCRIPTION
1	12528	325-2194	FORK ASSEMBLY
5	12261	320-5186	WEAR WASHER
6	12263	320-5187	SPACER TUBE
7	12250	320-5185	ROLLER BEARING
11	12268	325-2512	HUB ONLY

Bushhog Tail Wheel Replacement Parts

- 325-2149..... SPINDLE BOLT FOR BUSH HOG (1317BH)
- 325-2197..... BUSHING FOR BH TAILWHEEL KIT

TAILWHEEL FORK BUSHINGS

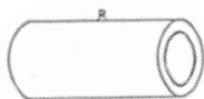

THESE BUSHINGS ARE WELD-ON REPLACEMENT FOR MOWER DECK BUSHINGS TO HOLD TAILWHEEL FORK. COMES WITH ZERK FITTINGS. 2-3/8" O.D. 6" LENGTH.

PART NO.	SIZE
325-2198	1 1/2" I.D.
101-7134	1 5/8" I.D.