

HR30 Hydraulic Tank

Operator's Manual



Click here to register your product!



MODERN
AG PRODUCTS, LTD.

YOU'RE ALWAYS AHEAD...WITH A MODERN BEHIND.

P.O. BOX 790 • BEAUMONT, TX 77704
409.833.2665 • 1.800.231.8198 FAX: 409.726.8333
www.modernusa.com

Go Galvanized!

Pre-Delivery Checklist

The Dealer should inform the Purchaser of this product of the Warranty terms, provisions, and procedures that are applicable. The Dealer and Purchaser should review the contents of the Operator's Manual including safety equipment, safe operation and maintenance, review the Safety Signs on the implement (and tractor if necessary), and the Purchaser's responsibility to train their operators in safe operation procedures.

- IMPLEMENTS: I have explained that the chain must be used on the pump to avoid damaging the unit. I have also explained that it was designed specifically for the Path Slayer Front End Mower, and it is not intended for any other use.
- HYDRAULICS: I have made certain that the hydraulic supply pump, hoses, and motor is in good repair and fastened securely in place to prevent injuries.

PRE-DELIVERY SERVICE CHECK AND ADJUST OR LUBRICATE AS REQUIRED

Refer to this Manual for Details

Inspection Performed - Warranty and Safety Procedures Explained - Installation Complete
LUBRICATION, HYDRAULICS, & HARDWARE

- Make Sure All Hardware Is Properly Tightened
- Check All Hoses and Coupling for Damage or Leaks.
- 20 Gallons of Hydraulic Fluid for the Hydraulic Reservoir.

RESERVOIR TO TRACTOR CONNECTIONS

- Make Sure the Proper Hydraulic Connections Are Available on the Tractor and Implement

SAFETY ITEMS

- Make Sure Safety Decals Are Installed
- Review This Operator's Manual

I have thoroughly instructed the buyer on the above-described equipment. This review included the Operation and Parts Manual content, equipment care, adjustments, safe operation, and applicable warranty policy.

Date _____

Dealer Rep. Signature _____

The above equipment and Operator's Manual have been received by me (the purchaser), and I have been thoroughly instructed as to care, adjustments, safe operation, and applicable warranty policy. **As the purchaser I have read, understand, and take responsibility for the use of this attachment. I understand and accept responsibility for the proper use of this Hydraulic Reservoir System. I acknowledge this unit is dangerous if not used correctly or if the safety information is not followed.**

Date _____

Owner's Signature _____

1. Table of Contents

2. INTRODUCTION	6	6. TRANSPORTING	21
2.1 Welcome	6	6.1 Transporting Safety (Road)	21
2.2 Safe Operation	6	7. STORAGE	22
2.3 Intended Usage	6	7.1 Storage Safety	22
2.4 Owner/Operator Manual Storage	7	7.2 Placing In Storage	22
2.5 Operator Orientation	7	7.3 Removing From Storage	22
2.6 Serial Number Location	7	8. SERVICE AND MAINTENANCE	23
2.7 Product Improvements	7	8.1 Maintenance Safety	23
2.8 Disposal of Equipment at End of Useful Life ..	7	8.2 Hydraulic Fluid Maintenance	24
2.9 Unanswered Questions	7	8.2.1 Check Fluid Level	24
3. SAFETY	8	8.2.2 Replace Filter Element	24
3.1 General	8	8.2.3 Change Hydraulic Fluid	24
3.2 Safety Alert Symbols	8	8.3 Service Record	24
3.3 Safety Icon Nomenclature	9	8.4 Welding Repairs	24
3.3.1 Personal Protection/Important		9. PARTS	25
Information	9	10. WARRANTY	27
3.3.2 Prohibited Actions	9		
3.3.3 Hazard Avoidance	9		
3.4 General Safety Instruction	10		
3.5 Training	11		
3.6 OSHA Training Requirements	11		
3.7 Federal Laws and Regulations	12		
3.8 Sign-Off Form	13		
3.9 Operation Safety	14		
3.10 Transportation Safety	14		
3.11 Storage Safety	14		
3.12 Maintenance Safety	14		
4. SAFETY SIGNS AND INSTRUCTIONAL			
LABELS	15		
4.1 General Information	15		
4.2 How to Install Replacement Safety Signs	15		
4.3 Safety Signs	16		
5. OPERATION	17		
5.1 Operating Safety	17		
5.2 Work Area Safety	17		
5.3 Tractor Requirements	18		
5.4 Attaching to Tractor	18		
5.5 Fill Hydraulic Reservoir	19		
5.6 Detaching from Tractor	20		
5.7 Reservoir Checklist	20		

2. INTRODUCTION

2.1 Welcome



Standard Configuration of the Hydraulic Reservoir System

Congratulations on your choice of a HR30 Hydraulic Reservoir System. This equipment has been designed and manufactured to meet the needs of discerning users.

The HR30 Reservoir System was designed to use with the Path Slayer offset mower.

Many features incorporated into this unit are the result of suggestions made by customers like you. Read this manual carefully to learn how to operate the Reservoir System safely and how to set up and maintain it to provide maximum efficiency.

The system uses a PTO motor to power the Reservoir Pump. At 540 RPM, the Reservoir System provides 15 gpm of fluid to the mower.

By following the operating instructions in conjunction with a good maintenance program, your HR30 Hydraulic Reservoir System will provide many years of trouble-free service.

2.2 Safe Operation

Safe, efficient, and trouble-free operation of your hydraulic reservoir system requires that you, and anyone else who will be using or maintaining the unit, read and understand the information contained within the Owner's Manual.

Use this manual for frequent reference and to pass on to new operators or owners.

⚠ WARNING



Read And Understand Manual

To prevent personal injury or even death, be sure you read and understand all of the instructions in this manual and other related OEM equipment manuals! The Hydraulic Reservoir System, if not used and maintained properly, can be dangerous to users unfamiliar with its operation. Do not allow operating, maintaining, adjusting, or cleaning of this system until the user has read this manual and has developed a thorough understanding of the safety precautions and functions of the unit.

DO NOT modify or use this system for any application other than that for which it was designed.

2.3 Intended Usage

Do not use this Hydraulic Reservoir System for any other purpose than its intended use.





This unit WILL NOT work on a 1000 RPM PTO.

⚠ CAUTION

Using the Reservoir System without the pressure relief valve will void the warranty and have the potential to cause damage to the offset mower and reservoir system.

2.4 Owner/Operator Manual Storage

Always store the Owner/Operator manual and other operating materials in the document storage tube located to the back of the reservoir tank.

2.5 Operator Orientation

The directions left, right, front, and rear, as mentioned throughout this manual, are as seen from the tractor operator's seat and facing in the direction of travel.

2.6 Serial Number Location

The serial number decal is located on the Top Link Lug.

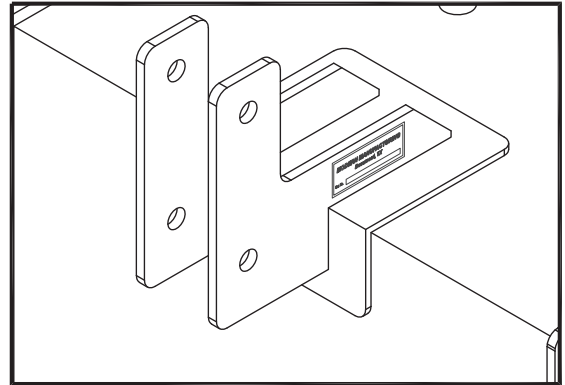

Model Number _____

Serial Number _____

2.7 Product Improvements

Because HR30 Attachments maintains an ongoing program of product improvement, we reserve the right to make improvements in design or changes in specifications without incurring any obligation to install them on units previously sold.

2.8 Disposal of Equipment at End of Useful Life

The HR30 Attachments hydraulic reservoir system has been designed for the specific purpose of powering the offset mower. When this unit is no longer capable of doing its designed purpose, it should be dismantled and scrapped. Do not use any materials or components from this unit for any other purpose.

2.9 Unanswered Questions

If you have any questions not answered in this manual or require additional copies or the manual is damaged, please contact your dealer or:

3. Safety

3.1 General

Safety of the operator and bystanders is one of the main concerns in designing and developing a new piece of equipment. Designers and manufacturers build in as many safety features as possible. However, every year many accidents occur which could have been avoided by a few seconds of thought and a more careful approach to handling the equipment.

Most work-related accidents are caused by failure to observe basic safety rules or precautions. An accident can often be avoided by recognizing potentially hazardous situations before an accident occurs. As you assemble, operate, or maintain the hydraulic reservoir system (unit), you must be alert to potential hazards. You should also have the necessary training, skills, and tools to perform any assembly or maintenance procedures.

Improper operation and maintenance of this unit could result in a dangerous situation that could cause injury or death.

If you have any questions not answered in this manual or require additional copies or the manual is damaged, please contact your dealer or:

Modern Inc. Beaumont,
Tx 77642

Phone: 800-231-8198
Fax: 800-726-8333

WARNING



Do not assemble, operate, or maintain the unit until you read and understand the information contained in this manual.



Safety precautions and warnings are provided in this manual and on the unit. If these hazard warnings are not heeded, bodily injury or death could occur to you or to other persons.

Modern Inc. cannot anticipate every possible circumstance that might involve a potential hazard. The warnings in this manual and on the unit are, therefore, not all-inclusive. If a method of assembly, operation, or maintenance not specifically recommended by us is used, you must satisfy yourself that it is safe for you and for others. You should also ensure that the unit will not be damaged or be made unsafe by the methods that you choose.

The information, specifications, and illustrations in this manual are based on the information that was available at the time this material was written and can change at any time without notice.

3.2 Safety Alert Symbols



This is the safety alert symbol. It is used to alert you to potential personal injury hazards. Obey all safety messages that follow this symbol to avoid possible injury or death.

This manual contains DANGERS, SAFETY INSTRUCTIONS, CAUTIONS, IMPORTANT NOTICES, and NOTES which must be followed to prevent the possibility of improper service, damage to the equipment, personal injury, or death. The following keywords call the readers' attention to potential hazards.

Hazards are identified by the "Safety Alert Symbol" and followed by a signal word such as "DANGER", "WARNING", or "CAUTION".

DANGER

Indicates an imminently hazardous situation which, if not avoided, will result in death or serious injury. This signal word is limited to the most extreme situations.

WARNING

Indicates a potentially hazardous situation which, if not avoided, could result in death or serious injury.

CAUTION

Indicates a potentially hazardous situation which, if not avoided, may result in minor or moderate injury.

NOTICE

Indicates that equipment or property damage can result if instructions are not followed.

SAFETY INSTRUCTIONS

Safety instructions (or equivalent) signs indicate specific safety-related instructions or procedures.

Note: Contains additional information important to a procedure.

3.3 Safety Icon Nomenclature

Pictorial icons signal a type of hazard and warn of personal protection issues, prohibited actions, and hazard avoidance.

3.3.1 Personal Protection/ Important Information







-  Read the manual
-  Maintenance procedure
-  Damaged hazard label
-  Eye protection
-  Fire extinguisher
-  First aid kit
-  Hand protection
-  Head protection
-  Hearing protection
-  Inspect equipment
-  OEM parts only
-  Protective shoes
-  Remove key
-  Set parking brake
-  Stop engine
-  Think safety
-  Transmission in park
-  Stop engine
-  Use proper support
-  Use proper tools

















-  Use two people when lifting heavy objects
-  Visibility
-  Rollover protection
-  Wear seat belt
-  Weight rating
-  Chemical flushing kit

3.3.2 Prohibited Actions

-  Do not alter or modify
-  Use proper tools
-  Do not weld
-  No alcohol
-  No drugs
-  No smoking
-  No young children
-  No riders

3.3.3 Hazard Avoidance

-    Crush hazard
-  Crush hazard (chock wheels)
-  Crush hazard (foot)
-  Defective or broken part
-  Entanglement hazard

-  Explosive force hazard
-  Explosive separation hazard
-  Fall hazard
-  Fire Hazard
-  Cutter blade contact hazard (hand)
-  Cutter blade contact hazard (foot)
-  Lifting hazard
-  Cutting hazard
-  Pinch point hazard
-  Projectile hazard
-  Rollover protection
-  Safety alert symbol
-  Safety shields
-  Sharp object hazard
-  Slipping Injury
-  Tire pressure
-  Tripping injury

3.4 General Safety Instruction

The owner/operator is responsible for the SAFE use and maintenance of the hydraulic reservoir system. Make sure anyone who is operating, maintaining, or working around the unit is familiar with the operating and maintenance procedures and related SAFETY information contained in this manual. This manual will take you step-by-step through your working day and alerts you to all good safety practices that should be used while using the unit.

In addition to the design features of the unit including safety signs, accident prevention is dependent upon the awareness, concern, prudence, and proper training of the people involved in the operation, maintenance, and storage of the unit.

In addition to this safety section, refer also to safety messages and instructions in each of the appropriate sections of the manual.

These general safety instructions apply to the overall use and maintenance of the hydraulic reservoir system.

More specific instructions on safety are found in the operation, maintenance, and storage sections of this manual. Refer to these sections before performing any of these tasks.

⚠ WARNING

Failure to comply with the following safety instructions can and will result in serious injury and possibly even death if they are not understood and followed.



Read and Understand Manual

To prevent personal injury or even death, be sure you read and understand all of the instructions in this manual and other related OEM equipment manuals! The HR30 hydraulic reservoir system, if not used and maintained properly, can be dangerous to users unfamiliar with its operation. Do not allow operating, maintaining, adjusting, or cleaning of this unit until the user has read this manual and has developed a thorough understanding of the safety precautions and functions of the unit.

This reservoir system is designed for the specific purpose of cutting grass, weeds, and light brush. **DO NOT** modify or use this unit for any application other than that for which it was designed.

This unit maintained or operated improperly, or by untrained personnel, can be dangerous; exposing the user and/or bystanders to possible serious injury or death.

⚠ WARNING



Provide User with Literature

HR30 hydraulic reservoir system owners must provide operator instructions to anyone using the unit before use, and at least annually

thereafter. Refer to “3.6 OSHA Training Requirements” on page 11.



Stay Clear

Clear the area of people, especially small children, before using the reservoir system.

Under no circumstances should young children be allowed to work with or around the unit.



Impaired User Hazard

Do not attempt to assemble, operate, or maintain this unit under the influence of drugs or alcohol.

Consult your doctor before using this unit while taking prescription medications.



Crush Hazard

Do not allow anyone to ride on the tractor or the reservoir system. Falling or crushing hazards can result in severe injuries or death.



Falling Hazard

Do not allow riders on the hitch, tractor, or hydraulic reservoir system at any time. Falling can result in severe injuries or death.



No Unauthorized Modifications

Do not modify the reservoir system or safety devices. Do not weld on the unit. Unauthorized modifications may impair its function and safety. Personal injury or death can result from unauthorized modifications.

If the hydraulic reservoir system has been altered in any way from the original design, Trailblazer does not accept any liability for injury or warranty.



Damaged Parts Hazard

Do not use the reservoir system if any parts are damaged. If the unit has a defect, immediately stop using it and remedy the problem before continuing.



Entanglement Hazard

Always disengage the PTO and turn off tractor before checking fluid level. Do not engage the tractor PTO when unhooking and hooking up the pump to the PTO shaft. Do not stand near the PTO while rotating.

⚠ CAUTION

The following safety instructions are provided to help prevent potential injury. Not following these instructions may lead to injury.

Personal Protection Equipment

When using this reservoir system, wear appropriate personal protective equipment. This list may include, but is not limited to:



- Protective shoes with slip resistant soles
- Protective goggles, glasses, or face shield
- Protective clothing and gloves
- Safety vest (when operating near roads)
- Hearing protection



 **Ear Protection**
Wear suitable ear protection during prolonged exposure to excessive noise.

 **Hearing Loss**
Prolonged Exposure To Loud Noise May Cause Permanent Hearing Loss!

Working environments with noise-producing equipment can cause partial to permanent hearing loss. We recommend using hearing protection any time noise levels exceed 80 decibels (dB). Noise levels over 85 dB, on a long-term basis, can cause severe hearing loss. Noise levels over 90 dB over a period of time can cause permanent and even total hearing loss.

Hearing loss from loud noise is cumulative over a lifetime without hope of natural recovery.

Crush Hazard

  The tractor should be equipped with a Roll Over Protective Structure (ROPS) and a seat belt. A crushing hazard can occur if the driver is ejected from the seat while the tractor is in motion. Fasten the seat belt whenever the tractor is moving.

Fire Extinguisher

 Have a fire extinguisher available for use should the need arise and know how to use it. Always keep a fire extinguisher rated "ABC" nearby.

High Pressure Fluids

 Relieve the pressure before disconnecting hydraulic lines or performing work on the system. Ensure all hydraulic fluid connections are tight. Check all hoses and lines to make sure they are in good position before applying pressure to the system.

SAFETY INSTRUCTIONS

The following safety instructions are provided to help prevent injury or limit equipment damage.

Safety Signs



Replace any missing or hard-to-read safety signs or instructional labels. Use care when washing or cleaning the reservoir system.

Replacement safety sign locations and part numbers are provided in this manual and are available from an authorized dealer parts department or the factory.



First Aid Kit

Have a first aid kit available for use should the need arise and know how to use it.

Hand protection



Do not touch the exterior of the reservoir. It can become hot during operation



Think SAFETY!

Work SAFELY!

3.5 Training

Anyone who will be using and/or maintaining the reservoir system must read, clearly understand, and follow ALL safety, operation, and maintenance information presented in this manual, other related OEM manuals, and the safety signs.

If you do not understand any information in this manual, see your dealer or contact Modern Inc., before proceeding.

Do not use or allow anyone else to use this reservoir system until all information has been reviewed. Annually review this manual before the season start-up.

Make periodic reviews of SAFETY and OPERATION of the reservoir system a standard practice. An untrained operator is not qualified to use this reservoir system.

3.6 OSHA Training Requirements

The following training requirements have been taken from Title 29, Code of Federal Regulations Part 1928.57 (a) (6). www.osha.gov.

Operator instructions. At the time of initial assignment and at least annually thereafter, the employer shall instruct every employee who operates an agricultural tractor and implements in the safe operating practices and servicing of equipment with which they are or will be involved, and of any other practices dictated by the work environment.

3.7 Federal Laws and Regulations

IMPORTANT FEDERAL LAWS AND REGULATIONS CONCERNING EMPLOYERS, EMPLOYEES AND OPERATORS

This sections is intended to explain in broad terms the concept and effect of the following federal laws and regulations. It is not intended as a legal interpretation of the laws and should not be considered as such.

U.S. PUBLIC LAW 91-596 (The Williams-Steiger Occupational Safety and Health Act of 1970) OSHA

This Act Seeks:

" ... to assure so far as possible every working man and woman in the nation safe and healthful working conditions and to preserve our human resources ... "

DUTIES

Sec. 5(a) Each Employer -

- (1) shall furnish to each of its employees employment and a place of employment which are free from recognized hazards that are causing or are likely to cause death or serious physical harm to its employees.
- (2) shall comply with occupational safety and health standards promulgated under this Act.
 - (b) Each employee shall comply with occupational safety and health standards and all rules, regulations, and orders issued pursuant to this Act which are applicable to his or her own actions and conduct.

OSHA Regulations

Current OSHA regulations state in part: "At the time of initial assignment and at least annually thereafter, the employer shall instruct every employee in the safe operation and servicing of all equipment with which the employee is, or will be involved." These will include (but are not limited to) instructions to:

Keep all guards in place when the machine is in operation;

Permit no riders on equipment;

Stop engine, disconnect the power source, and wait for all machine movement to stop before servicing, adjusting, cleaning, or unclogging the equipment, except where the machine must be running to be properly serviced or maintained, in which case the employer shall instruct employees as to all steps and procedures which are necessary to safely service or maintain equipment.

Make sure no one is within 300 feet of machinery before starting the engine, engaging power, or operating the machine.

EMPLOYEE TRACTOR OPERATING INSTRUCTIONS:

1. Securely fasten your seat belt if the tractor has a ROPS.
2. Where possible, avoid operating the tractor near ditches, embankments, and holes.
3. Reduce speed when turning, crossing slopes, and on rough, slick, or muddy surfaces.
4. Stay off slopes too steep for safe operation.
5. Watch where you are going, especially at row ends, on roads, and around trees.
6. Do not permit others to ride.
7. Operate the tractor smoothly - no jerky turns, starts, or stops.
8. Hitch only to the drawbar and hitch points recommended by tractor manufacturers.
9. When tractor is stopped, set brakes securely and use park lock if available.

Child Labor Under 16 Years Old

Some regulations specify that no one under the age of 16 may operate power machinery. It is your responsibility to know what these regulations are in your own area or situation. (Refer to U.S. Dept. of Labor, Employment Standard Administration, Wage & Home Division, Child Labor Bulletin #102).

3.9 Operation Safety

Refer to the Operation section for safety recommendations related to using the reservoir system. All applicable safety recommendations in other sections should also be followed.

3.10 Transporting Safety

Refer to the Transporting section for safety recommendations related to transporting the reservoir system. All applicable safety recommendations in other sections should also be followed.

3.11 Storage Safety

Refer to the Storage section for safety recommendations related to storing the reservoir system. All applicable safety recommendations in other sections should also be followed.

3.12 Maintenance Safety

Refer to the Service and Maintenance section for safety recommendations related to maintaining the reservoir system. All applicable safety recommendations in other sections should also be followed.

4. SAFETY SIGNS AND INSTRUCTIONAL LABELS

4.1 General Information

The types of safety signs (hazard labels) and instructional labels, along with their locations on the equipment, are shown in the following illustrations. Good safety practices require that you familiarize yourself with the various safety signs, the type of warning, and the area or particular operation related to that area that requires your SAFETY AWARENESS.



Think SAFETY!

Work SAFELY!

Pay close attention to the safety signs and instructional labels attached to the tractor and the reservoir system. Duplicate safety signs, which are attached to the reservoir system, can also be found in this section. If the hydraulic reservoir system is missing a label or one is unreadable, replace the label before using the unit.

SAFETY
INSTRUCTIONS



Safety Signs and Instructional Labels

1. Keep safety signs or instructional labels clean and legible at all times. Use a clean, damp cloth to clean safety decals.

2. Replace any missing or hard-to-read safety signs or instructional labels.

3. Use care when washing or cleaning the equipment not to remove or damage the labels. When using a pressure washer to clean the unit, avoid spraying too close to decals; high-pressure water can enter through very small scratches or under edges of decals causing them to peel or come off.

4. Locations for the labels and replacement part numbers are shown in this section.

5. Replacement parts must have replacement labels attached during installation and/or before the reservoir system is used.

6. Labels are available from your authorized dealer at no charge.

4.2 How to Install Replacement Safety Signs

1. Clean and dry the installation area.

Note: Do not install the signs if the temperature is below 50°F (10°C).

2. Determine the exact position before you remove the backing paper.
3. Remove the backing paper.
4. Align the sign over the specified area and carefully press the sign to the part/frame.

Note: Small air pockets can be pierced with a pin and smoothed out using the piece of backing paper.

4.3 Safety Signs



HR30 DECAL LIST

<u>Item</u>	<u>Part Number</u>	<u>Description</u>	<u>Qty</u>
1.....	475-5041.....	Modern AG Logo.....	1
2.....	490-1012.....	HR30.....	1
3.....	490-1028.....	Warning.....	1
4.....	490-5010.....	Danger: Do Not Operate.....	1
5.....	490-1023.....	American Flag.....	1
6.....	490-FEMA.....	FEMA.....	1
7.....	490-1031.....	Modern AG Products.....	1

5. Operation

5.1 Operating Safety

WARNING

Crush Hazard



The tractor should be equipped with a Roll Over Protective Structure (ROPS) and a seat belt. A crushing hazard can occur if the driver is ejected from the seat while the tractor is in motion. Fasten the seat belt whenever the tractor is moving.



Roll Away Hazard

Before leaving the tractor seat, make sure the engine is stopped, the transmission is placed in park, the key is removed, and the parking brake is set.



The weight of the tractor, plus the reservoir system if it rolls onto a person, can cause serious crushing injury or death.



Stay Clear

Clear the work area of all unnecessary people and obstructions to prevent personal injury.



Entanglement hazard

To avoid serious injury or death, ensure PTO is off while hooking up the Hydraulic Reservoir system. Make sure the safety chain is not in the area of the PTO



Think Safety

To avoid serious injury or death, do not use the hydraulic reservoir system to push or carry objects.



Think Safety

Never remove the hydraulic fill cap during operation. Hot oil can escape causing severe burns. Allow hydraulic system to cool completely before removing hydraulic oil fill cap.



Think Safety

Ensure hydraulic hoses are properly routed with no kinks or twists. If the hydraulic lines become pinched, kinked, or blocked they can burst leaking hydraulic fluid and could cause serious injury or death.

SAFETY INSTRUCTIONS

The following safety instructions are provided to help prevent injury or limit equipment damage.

Train Unfamiliar Users



It is the Reservoir system owner's responsibility to make sure any person using the unit, especially if it is loaned or rented, has been thoroughly trained on its proper and safe use.

Train all new users and review instructions annually with existing users.

Be certain only physically-able persons will use the reservoir system.

Users who have not read and understood all operating and safety instructions are not qualified to use the reservoir system.

Untrained users expose themselves and bystanders to possible serious injury or death.

If the elderly are assisting with the work, their physical limitations need to be recognized and accommodated.

Never allow children to operate equipment.

5.2 Work Area Safety

SAFETY INSTRUCTIONS

The following safety instructions are provided to help prevent injury or limit equipment damage.

Never operate the unit in darkness or foggy conditions where you cannot clearly see at least 300 feet in front and to the sides of the tractor and reservoir system.

Make sure that you can clearly see and identify passersby, steep slopes, ditches, drop-offs, overhead obstructions, power lines, debris, and foreign objects. If you are unable to clearly see these type of items, stop operating the hydraulic reservoir system.

Do not operate the reservoir system, or drive the tractor into material that is burning, or areas that recently burnt and may contain hot embers. Burning material, sparks, and coals could be thrown from the reservoir system to areas of vegetation that might ignite.

**SAFETY
INSTRUCTIONS**

The following safety instructions are provided to help prevent injury or limit equipment damage.

Carry a fire extinguisher on the tractor at all times to extinguish possible fires encountered.

Do not operate the reservoir system on a tractor with an under-frame exhaust.

Before turning, slightly raise the unit off the ground.

After the pump is hydraulically disengaged, the motor can free-wheel for several minutes. Stay clear of the shaft until it comes to complete stop.

Stay alert and watch for trees, low hanging limbs, power lines, and other overhead obstacles as well as solid ground objects.

Do not use the hydraulic reservoir system to push objects.

5.3 Tractor Requirements

WARNING



Tractor Owner/Operator Manual

Always refer to the tractor owner's manual to ensure compatibility and maximum safety.

The tractor used to operate the reservoir system must have the power capacity to lift and move the unit.

Minimum 15 HP required to run the Hydraulic Reservoir System.

Operating the reservoir system with a tractor that does not meet the following requirements may cause tractor or reservoir system damage and be a potential danger to the operator and passersby.

NOTICE

Some tractors are available with multispeed PTO. Ensure your tractor's PTO is set to 540 RPM to prevent damage to the implement.

CAUTION

Do not operate the Hydraulic Reservoir System while it is unhooked from the tractor's 3-point hitch. This unit could become unstable if not properly attached to a tractor during operation

Always review the "controls" section of the tractor operator's manual to be familiar with the location, settings, and function of the tractor controls. Be familiar with all controls before using this equipment.

- Approved Roll-Over Protective Structure (ROPS) or ROPS cab and seat belt.
- Tractor Safety Devices; Slow Moving Vehicle (SMV) emblem, lighting.

5.4 Attaching to Tractor

Use caution when connecting the reservoir system to the tractor. The reservoir system should be securely resting at ground level or setting on blocks. Keep hands and feet from under the unit and clear of pinch points between the tractor hitch arms and reservoir system hitch pins.

WARNING



Crush Hazard

Crush hazard between tractor and reservoir system. Do not allow anyone to stand between the tractor and implement during hook-up operations.

1. Slowly back the tractor to the Hydraulic Reservoir System and align the lower lift arm hitch holes with the lug holes on the reservoir using the tractor's 3-point hydraulic controls.
2. Engage the tractor's parking brake and shut the tractor engine off. Remove the key before dismounting from the tractor.
3. With the lower hitch arms on the tractor aligned and positioned between the lug holes on the reservoir, insert the lower 3-point hitch pins through the lug holes on the reservoir. Secure the pins with lynch pins.
4. Connect top center link on the tractor to the top center link mounting holes on the reservoir system using the top link pin and hairpin cotter.
5. Torque arm kit chain to be approximately 90 degrees with torque arm. Secure end of chain to rigid surface, safety wire S-hook to chain. Chain should be perpendicular to slightly forward of perpendicular to shaft. The drive shaft must extend into the pump a minimum of 3" for a 6 tooth spline.

**** All tractors are configured uniquely, consult with your Dealer to verify best mounting practices for your tractor ****

6. Transporting

6.1 Transporting Safety (Road)

WARNING

The following safety instructions can and will result in serious injury and possibly even death if they are not understood and followed.

Tractor Owner/Operator Manual

Always refer to the tractor owner's manual to determine its compatibility and maximum safety.

Operating the Tractor



Before attaching the reservoir system to the tractor, be familiar with its controls and how to stop it quickly in the event of an emergency. Read and understand this manual and the one provided with your tractor before transporting the unit.



Fall and Crush Hazard

Do not allow riders on the reservoir system or tractor.



Maximum Transporting Speed

Do not exceed 20 MPH when transporting the reservoir system. Slow down for corners and rough terrain.



Visibility

Clean reflectors, SMV or SIS sign, and lights before towing. Make sure all the lights and reflectors required by highway and transport authorities are in place and can be seen clearly by all overtaking and oncoming traffic.



Regulations

Make sure all local, state, and federal regulations, regarding the transport of equipment on public roads and highways, are met. Check with the local authorities regarding transporting the reservoir system on public roads. Obey all applicable laws and regulations.



Rollover Protection

The tractor should be equipped with a Roll Over Protective Structure (ROPS) and a seat belt.

SAFETY INSTRUCTIONS

The following safety instructions are provided to help prevent injury or limit equipment damage.



Drive Safely

Be a safe and courteous driver. Anticipate what other drivers will do and drive accordingly.



Allow Extra Distance

Apply brakes early. Leave extra distance between your vehicle and the one(s) ahead to provide adequate stopping space. Extra distance will be required to stop the vehicle.



Clear Vision

Remove all objects from the area that would prevent clear vision of the complete work area or would present an obstacle when moving the reservoir system.



Hitch Attachment

Be sure the reservoir system is securely attached to the tractor and in good operating condition before using.



Working Taillights

Make sure lights on the tractor are working properly.



Additional Lighting

For reservoir systems without lights, install additional lights on the rear of the tractor to safeguard against rear-end collisions. Daybreak and dusk are particularly dangerous and rear pilot vehicles are recommended. Reservoir systems without lights should be transported on public roads only during daylight hours.



Hazard Flashers

Use hazard flashers on the tractor when transporting unless prohibited by law.



Right-of-Way

When traveling below the posted speed limit, keep to the right and yield the right-of-way to allow faster traffic to pass.

7. Storage

7.1 Storage Safety

At the end of the season, the reservoir system should be thoroughly inspected and prepared for storage. Repair or replace any worn or damaged components to prevent any unnecessary downtime at the beginning of the next season.

CAUTION

Personal Injury Hazard



Store the reservoir system in an area away from human activity. To prevent the possibility of serious injury, do not permit children to play on or around the stored unit.



Crush Hazard

Always set the reservoir system on safety stands or on blocks for storage.

NOTICE

To prevent damage to the reservoir system, store it in a dry, level area.

7.2 Placing In Storage

1. Remove all entangled vegetation.
2. Thoroughly wash the reservoir system with a pressure washer or water hose to remove all grease, dirt, mud, or debris.
3. Select an area that is dry, level, and free of debris (inside a building is ideal). Move the reservoir system to its storage area.
4. Replace all damaged or missing decals.
5. Follow all detaching from tractor instructions when disconnecting tractor from the reservoir system.
6. Touch up all paint nicks and scratches to prevent rusting.

7.3 Removing From Storage

When removing the reservoir system from storage, follow this procedure:

1. Attach the reservoir system to the tractor 3 point hitch.
2. Raise the unit up off the blocks.
3. Before placing the reservoir system back into service, replace any worn or defective parts and perform the Pre-Operation Checklist.

8. Service and Maintenance

8.1 Maintenance Safety

WARNING

Failure to comply with the following safety instructions can and will result in serious injury and possibly even death.

Personal Protection Equipment



Wear close fitting and belted clothing to avoid getting caught in moving parts. Wear personal protection equipment (PPE), which may include hard hat, safety glasses, safety shoes, gloves, etc. appropriate for the work site and working conditions.

Damaged Parts Hazard



Do not use the reservoir system if any parts are damaged. If the unit is believed to have a defect which could cause it to work improperly, immediately stop using it and remedy the problem before continuing.



No Unauthorized Modifications

Do not modify the reservoir system or safety devices. Do not weld on the unit. Unauthorized modifications may impair its function and safety and will void the warranty.

If the reservoir system has been altered in any way from the original design, the manufacturer does not accept any liability for injury or warranty.



Crush Hazard

Always set the reservoir system on safety stands or on the ground when performing maintenance.



Good Working Condition

Keep all parts in good condition and properly installed. Fix damage immediately. Replace worn or broken parts.



Replacement Parts

If replacement parts are necessary, genuine factory replacement parts must be used to restore the unit to its original specifications. Modern AG will not accept responsibility for damages as a result of the use of unapproved parts.



Safety Shields and Devices

When completing a maintenance or service function, make sure all safety shields and devices are installed before placing the reservoir system in service.



Hand Safety

Never check for leaks with your hand.

Leaks can be located by holding a piece of cardboard or wood (at least 2 feet long) with your hand at one end and passing the other end over the suspected area (wear eye protection). Look for discoloration of the cardboard or wood. Hydraulic fluid escaping through a pinhole sized opening can burn or puncture skin, resulting in wounds that could cause blood poisoning, infection, disability, gangrene, amputation, or death.

If injured by escaping fluid, no matter how small the wound is, see a doctor at once. A typical injection may be a small wound that does not look serious. However, severe infection or reaction can result if proper medical treatment is not administered immediately by a doctor who is familiar with injection injuries.

SAFETY INSTRUCTIONS

The following safety instructions are provided to help prevent injury or limit equipment damage.



Safety Equipment

A fire extinguisher and first aid kit should be readily accessible while performing maintenance on this equipment.



Clean Work Area

Do not leave tools lying around the work area. Follow good shop practices. Keep service area clean and dry. Be sure electrical outlets and tools are properly grounded. Use adequate light.



Use the Right Tools

Use the correct tools, jacks, hoists or other tools that have the capacity for the job.



Proper Support

Use certified safety stands rated to support the load when working beneath the reservoir system, or performing repairs, service, or maintenance.

Before working underneath the reservoir system place it on a minimum of four jack stands, with a load rating of at least 1000 lbs. each. Make sure the jack stands are stable and the reservoir system is approximately level. Test the stability of the unit before working underneath.

If the reservoir system is attached to the tractor, set the brakes, remove the key, chock the tractor wheels, and block the reservoir system before working underneath.

8.2 Hydraulic Fluid Maintenance

One of the most important items to prevent problems is ensuring that the hydraulic oil reservoir is free of dirt and other containments.

8.2.1 Check Fluid Level

Check the fluid level every 8 hours of operation or if a spill or leak has occurred.

DO NOT attempt to add more hydraulic fluid during operation to extend the Hydraulic capacity.

1. Level Hydraulic Reservoir System.
2. Clean dirt and containments around the fill cap.
3. Remove the filler cap.
4. Add Hydraulic Fluid to the reservoir until the fluid reaches between the low and high in the sight glass.
5. Put the filler cap back on.

8.2.2 Replace Filter Element

Replace the filter element after every 75 hours of operation or if contamination occurs.

1. Place a drip pan under the filter to catch spilled hydraulic fluid
2. Unscrew filter element and drain the hydraulic fluid from the filter.
3. Clean the filter head
4. Replace oil filter with a conventional 10-micron filter and O-ring. Coat O-ring with clean hydraulic fluid.
5. Hand tighten filter. Tighten by turning filter an additional 7/8 of a turn.

8.3 Service Record

The period recommended is based on normal operating conditions. Severe or unusual conditions may require more frequent lubrication or oil changes.

Copy this page to continue record.

Hours and Served by												
	Every 8 Hours											
Make sure fasteners and clamps are properly tightened.												
Make sure all retainer clips and cotter pins are in place.												
Check Fluid Level, and check for leaks												
Inspect labels and hoses for damage												
Every 75 Hours												
Replace Filter Element												
Every 150 Hours												
Change Hydraulic Fluid												
Check unit, motor, and hoses for damage.												
Wash the reservoir system.												
Fill in any nicks in the paint												

8.2.3 Change Hydraulic Fluid

Change hydraulic fluid every 150 operating hours or every 2 years of service, whichever comes first.

1. Unbolt reservoir and slide forward.
2. Place a container with the ability to hold 20 gallons under the drain plug.
3. Remove the drain plug and filler cap.
4. Allow the hydraulic fluid to drain from the unit completely, and then replace the drain plug.
5. Slide Reservoir back and bolt reservoir back in place.
6. Fill the reservoir with 20 gallons of hydraulic fluid and replace the fill cap.

8.4 Welding Repairs



Before performing any type of welding repair to the reservoir system, contact Modern for approval. Repair welding must be done with care and with procedures that may be beyond the capabilities of the ordinary welder.



WARNING

Personal Injury Hazard

Repairs or modifications to the reservoir system can result in serious injury or death should these repairs fail.



NOTICE

Anyone performing a welding repair should be certified in accordance with the American Welding Society (AWS) standards.

Warranty Information

When purchasing from Modern AG, we guarantee that we deliver exactly what is seen and described in our advertisement. Except for the excluded products as described below, Modern AG warrants the original purchaser that this Modern AG product will be free from defects in material and workmanship beginning on the date of purchase when used as intended under normal circumstances and conditions.

1. Excluded Products. The following products are excluded from this limited warranty:
 - (a) Wear parts which include but are not limited to, retaining hardware, bearings, blades, and hydraulic hoses.
 - (b) Any product that in the opinion of Modern AG, has been misused, modified in an unauthorized manner, altered, damaged, involved in an accident, or repaired using parts not obtained through Modern AG.
2. Warranty Period. The limited warranty is provided only to those defects that occur during the warranty period. The warranty period begins on the purchase date as evidenced by the invoiced shipment date and ends one year (twelve months) from the purchase date.
3. Terms and Conditions of Limited Warranty. The following terms and conditions apply:
 - (a) Option to repair or replace. Modern AG shall have the option to repair or replace the product.
 - (b) If requested the alleged defective part or product shall be shipped to Modern AG with freight pre-paid by the claimant, to allow Modern AG to inspect the product.

Claims under this Warranty should be made to the dealer which originally sold the product and all warranty claims or repairs must be completed through an authorized Modern AG dealer. Modern AG reserves the right to make changes in materials or design of the product at any time without notice.

This Warranty shall not be interpreted to render Modern AG liable for damages of any kind, direct, consequential, or contingent to property. Furthermore, Modern AG shall not be liable for damages resulting from any cause beyond its reasonable control. This Warranty does not extend to loss of crops, any expense or loss for labor, supplies, rental machinery or for any other reason.

IMPORTANT: This Warranty is not valid unless:

1. Registered with Modern AG within 30 days from the date of original purchase.
2. Must be purchased from authorized dealer or Modern AG directly.
3. Warranty is NON-TRANSFERRABLE.

NOTE: Pictures of any damaged units must be sent before warranty requests will be fulfilled.

HR30 PARTS LIST

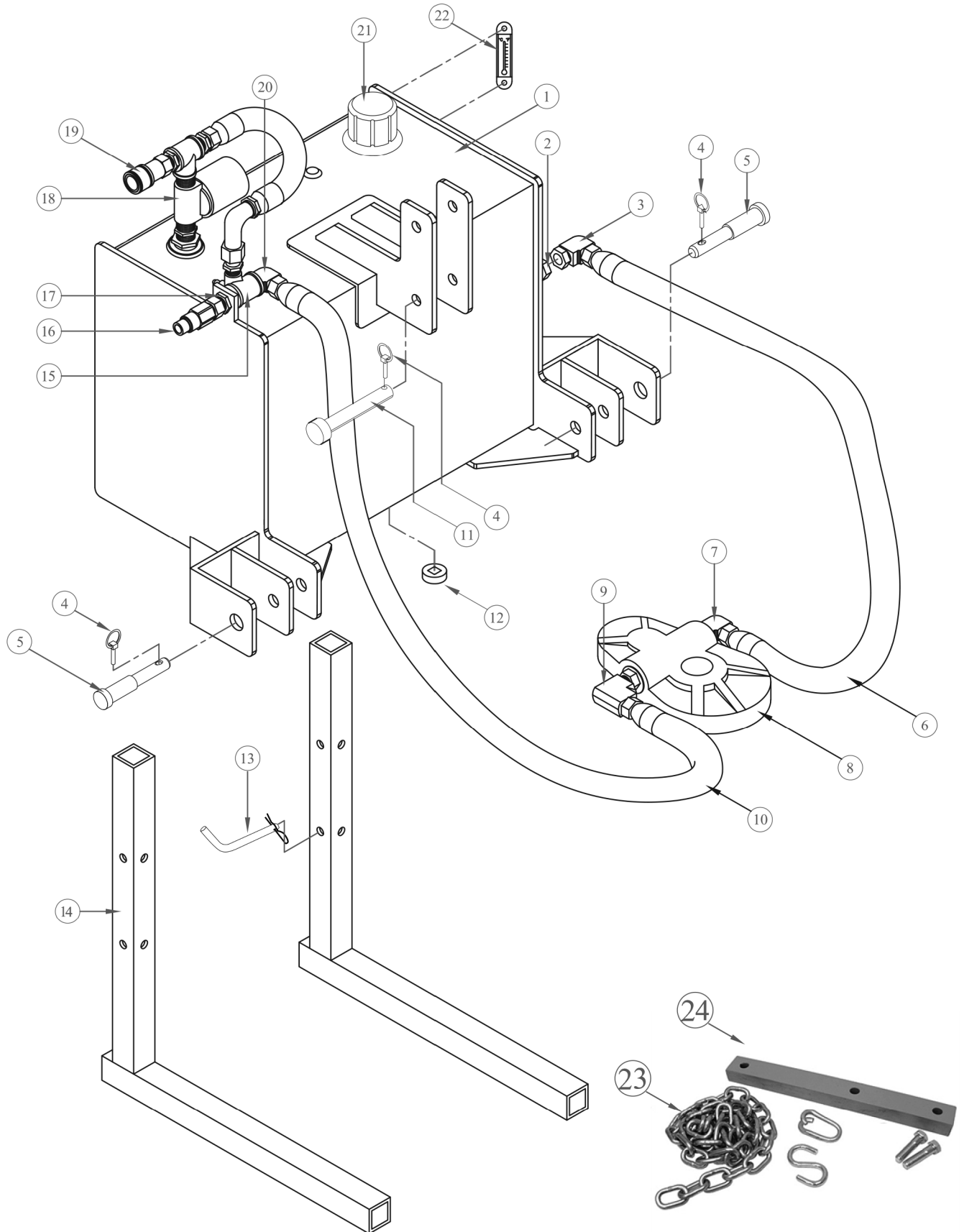

HR30 PARTS LIST

<u>ITEM</u>	<u>PART NO.</u>	<u>QUANTITY</u>	<u>DESCRIPTION</u>
1.....	201-1000	1	HR30 Tank
2.....	201-1005	1	Sump Strainer
3.....	201-1015	1	90° Fitting
4.....	154-1533	3	Lynch Pins
5.....	300-26385	2	Lift Pin
6.....	415-0033	1	16FXJ Hydraulic Hose
7.....	201-1016	1	90° Fitting
8.....	711-1004	1	Hydraulic Gear Pump
9.....	201-1015	1	90° Fitting
10.....	415-0032	1	12FXJ Hydraulic Hose
11.....	150-1464	1	Top Link Pin
12.....	201-1002	1	1" Drain Plug Magnetic
13.....	150-7112	2	Bent Hitch Pin 5/8" x 3"
14.....	103-3000	2	HR30 Leg Weldment
15.....	201-1007	1	(RD12D) Relief Valve
16.....	227-5054	1	1/2" NPLE FM Pipe
17.....	201-1008	1	Bolt Head Fitting
18.....	201-1006	1	Filter Head Assembly
19.....	227-5053	1	1/2" CPLR FM Pipe
20.....	201-1014	1	90° Fitting
21.....	201-1003	1	Breather Cap Assembly
22.....	201-1004	1	Oil Level W/Temp Indicator
23.....	343-1928	1	Safety chain
24.....	106-0002	1	Hold down bar

LIMITED WARRANTY POLICY & REGISTRATION

DEALER: I hereby certify that:

1. The machine has been correctly assembled in accordance with manufacturers instructions.
2. All bolts have been checked and tightened.
3. All other pre-delivery checks have been completed as per operators manual.
4. Purchaser was given operators manual and instructed in safe and correct usage of machine and on limitation of warranty.
5. Machine was tested and operates correctly.

PURCHASER: I hereby certify that:

1. The machine is correctly assembled.
2. Receipt of the operators manual which I have read and clearly understood.
3. I have a clear understanding of the warranty limitations.
4. I have a clear understanding on the correct and safe operation of the machine
5. That the machine needs regular maintenance as per instructions in operators manual.
6. I have a clear understanding on the capacity of this machine and am aware of its limitations.

MODEL _____

SERIAL # _____

DEALER _____ DATE DELIVERED _____

DEALER'S STAMP

MAIL TO:

PURCHASERS ADDRESS:

